

RADIO'S LIVEST MAGAZINE



April
25 Cents

Radio-Craft

HUGO GERNSBACK Editor

How to Build
This New
Oscillator—Tube Tester

See Page 586



A "2-Tube" Loudspeaker Set—A "General Purpose" Pentode Tube
Novel Radio Experiments—An R. F. Tuner Chassis—I. F. Coil Design

FIRST AGAIN!

NEW CABLE DEVELOPMENT AROUSES INDUSTRY

BROOKLYN, N. Y., Feb. 1.—The attention of leading set designers and manufacturers throughout this and other countries is focussed upon the latest creation of the SPEED laboratories here.

Many important manufacturers are rushing special chassis designs to accommodate this new tube.

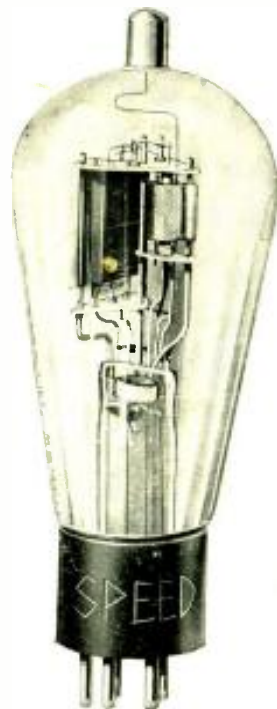

TRIPLE-TWIN

Aptly named the "TRIPLE-TWIN," this remarkable device delivers double the power of the conventional pentode and triple the power of the type 245, without any increase in plate voltages. It has five to ten times the output of tubes now used in DC receivers.

The "Triple-Twin" achieves greater sensitivity, allowing the elimination of pre-output stages. It is developed to replace not only the audio frequency amplifiers, but also the detector tube, thereby permitting great economy in

chassis construction.

The SPEED "TRIPLE-TWIN" is a boon to television, having a flat frequency response from thirty cycles to fifty thousand cycles.

"TRIPLE-TWIN" type 295 (AC) lists at \$3.50.

**SPEED
TRIPLE-TWIN**

was developed exclusively
in the laboratories of

CABLE RADIO TUBE CORP.
230-242 NORTH 9th STREET
BROOKLYN, N. Y.

SPEED

★ RADIO TUBES

General AC Series	General DC Series	Automobile Series
224	201A	236
235	199	237
551	WD11	238
226	WD12	239
227	120	
245	140	Low Wattage Series
247	112A	230
171AC	171A	231
	200A	232
Sparton Set Series	222	233
S83	Special Amplifier Series	Rectifiers
S82B	201A	280
S85	250	281
S84		

Triple-Twin Series:—Types 291, 293, 295.

High quality receiving tubes of exceptional life and operating characteristics. Used as initial equipment by many set manufacturers. Sold by leading retail institutions throughout the country.

★ FOTO-LECTRIC TUBES

Type A, tubular 16 mm. bulb, no base. Use with DeForest Phonofilm, Biophone, Kinoplay, etc.

Type B, tubular T8 bulb, no base. Type B4, with small 4-prong base. Use with Weber, Platter, Duo-fone, Brel, Eastern Electric, Kinetophone, Holmes, Ruby, etc.

Type C, tubular T8 bulb, no base. Types C1, C2 with small 4-prong base. Use with DeVry, RCA Photophone, Powers, etc.

Type D, tubular T12 bulb, with standard large 4-prong base. Type D2 applies to Pacent, Powers Cinephone, Royal Amplitone, Universal, Bell, National, Gries, etc.

Type E, globular G18½ bulb with special base. Applies to all types of Western Electric equipment.

Standard gas-filled types, red sensitive, caesium on caesium-oxide, silver-oxide base. Guaranteed against defects.

★ TELEVISION TUBES

One inch plate, Wall Electrode type offers improved efficiency and greatly increased high frequency response. May be operated directly in plate circuit of type 171A tube, and with plate current limitations in circuit of types 245 or 247.

Crater type is made in standard diameters of .0135", .020", .030" and .040". Other sizes are available on special order. For use in optical systems such as lens discs, mirror wheels, etc.



WRITE FOR CURRENT BULLETINS

Train *with* R.T.A. *for* Radio Service Work



Important and far-reaching developments in Radio create sudden demand for specially equipped and specially trained Radio Service Men.

This excellent set analyzer and trouble shooter included with our course of training

MANY skilled Radio Service Men are needed now to service all-electric sets. By becoming a certified R. T. A. Service Man, you can make big money, full time or spare time, and fit yourself for the big-pay opportunities that Radio offers.

We will quickly give you the training you need to qualify as a Radio Service Man . . . certify you . . . furnish you with a marvelous Radio Set Analyzer. This wonder instrument, together with our training, will enable you to compete successfully with experts who have been in the radio business for years. With its help you can quickly diagnose any ailing Radio set. The training we give you will enable you to make necessary analysis and repairs.

Serving as a "radio doctor" with this Radio Set Analyzer is but one of the many easy ways by which we help you make money out of Radio. Wiring rooms for Radio, installing and servicing sets for dealers, building and installing automobile Radio sets, constructing and installing short wave receivers . . . those are a few of the other ways in which our members are cashing in on Radio.

As a member of the Radio Training Association, you receive personal instruction from skilled Radio Engineers. Upon completion of the training, they will advise you personally on any problems which arise in your work. The Association will help you make money in your spare time, increase your pay, or start you in business. The easiest, quickest, best-paying way for you to get into Radio is by joining the Radio Training Association.

This amazing Radio Set Analyzer plus the instructions given you by the Association will transform you into an expert quickly. With it, you can locate troubles in all types of sets, test circuits, measure resistance and condenser capacities, detect defective tubes. Knowing how to make repairs is easy; knowing what the trouble is requires expert knowledge and a Radio Set Analyzer. With this Radio Set Analyzer, you will be able to give expert service and make big money. Possessing this set analyzer and knowing how to use it will be but one of the benefits that will be yours as a member of the R. T. A.

Write for No-Cost Membership Plan

We have worked out a plan whereby a membership enrollment need not cost you a cent. Our thorough training and the valuable Radio set analyzer can be yours. Write at once and find out how easily both of these can be earned.

Now is the time to prepare to be a Radio Service Man. Greater opportunities are opening up right along. For the sake of extra money in your spare time, bigger pay, a business of your own, a position with a future, get in touch with the Radio Training Association of America now.

Send for this No-Cost Membership plan and Free Radio Handbook that will open your eyes as to what Radio has in store for the ambitious man. Don't wait. Do it now.

RADIO TRAINING ASSOCIATION OF AMERICA
Dept. RCA-4 4513 Ravenswood Ave. Chicago, Ill.

Fill Out and Mail Today!

RADIO TRAINING ASSOCIATION OF AMERICA
Dept. RCA-4, 4513 Ravenswood Ave., Chicago, Ill.

Gentlemen: Send me details of your No-Cost Membership Enrollment Plan and information on how to learn to make real money in radio quick.

Name

Address

City..... State.....

H. GERNSBACK, President
 S. GERNSBACK, Treasurer
 J. M. HERZBERG, Vice-President
 I. S. MANHEIMER, Secretary



R. D. WASHBURNE
 Technical Editor

LOUIS MARTIN
 Associate Editor

VOLUME III
 NUMBER 10

Contents of This Issue

APRIL
 1932

	PAGE		PAGE
EDITORIAL:			
The Broadcast Situation.....By Hugo Gernsback	585	Grief and Radio Service.....By D. V. Simpson	618
NEW DEVELOPMENTS IN RADIO:			
The Latest Radio Tubes.....By Louis Martin	588	A Tube Sucker.....By Morton W. Sterns	619
The Latest Radio Equipment.....	590	Something for the DX Fan.....By C. H. W. Nason	621
SERVICE MEN'S DEPARTMENT:			
How to Build This New Oscillator—Tube Tester, By Alfred W. Bulkeley	586	SOUND RECORDING DEPARTMENT:	
The Official Radio Service Men's Association By Fred Boehm	601	Fidelity in Home Recording.....By George J. Saliba	610
Operating Notes:		TECHNICAL RADIO TOPICS:	
The Analysis of Radio Receiver Symptoms By D. C. McCall	602	The RADIO-CRAFT "Triple-Twin" Receiver By the Engineering Staff of RADIO-CRAFT	592
Philcos, Boschs, and Stromberg-Carlsons By Bertram M. Freed	603	The "Comet" All-Wave Set.....By Martin W. Lewis	594
RADIO SERVICE DATA SHEETS:			
No. 63: Kennedy Superheterodyne Converter, Model 54 "Globe Trotter".....	606	I.F. Coil Design.....By Clifford E. Denton	596
No. 64: RCA-Victor Radiola Model M-30 Automotive Receiver	607	An R. F. Tuner Chassis.....By A. S. Waring	598
Dissecting a Modern Set Tester (Part III), "The Analyzer"	611	An Improved Band Selector.....By H. F. Dalpayrat	600
		The Craftsman's Page.....By RADIO-CRAFT Readers	608
		Some Novel Radio Experiments.....By John D. Adams	609
		A New S.-W. Receiver (Part II).....By McMurdo Silver	612
		Radio Kinks	614
		RADIO-CRAFT'S Information Bureau.....	616
		RADIO-CRAFT Readers' Bureau.....	634

In Forthcoming Issues

A SIMPLIFIED RADIO RECEIVER. A schematic diagram, list of parts, and complete data for building an ultra-modern, low-priced all-electric midget radio set.

CRATER LAMP OPERATION. Numerous circuit arrangements for utilizing to best advantage the intense light which may be obtained from television neon lamps of the "crater" type.

APPLICATIONS OF PUBLIC ADDRESS AMPLIFIERS. Many methods by which the progressive Service Man may capitalize his knowledge of audio amplifiers and reproducers.

BUILDING THE MODEL II-2 TETRODYNE RECEIVER. Complete details for the construction of a modern superheterodyne radio set of extremely high sensitivity and tone quality.

RADIO-CRAFT is published monthly, on the fifth of the month preceding that of date; its subscription price is \$2.50 per year. (In Canada and foreign countries, \$3.00 a year to cover additional postage.) Entered at the postoffice at Mt. Morris, Ill., as second-class matter under the act of March 3, 1879. Trademark and copyright by permission of Gernsback Publications, Inc., 98 Park Place, N. Y. C.

Text and illustrations of this magazine are copyright and must not be reproduced without permission of the copyright owners. We are also agents for WONDER STORIES and WONDER STORIES QUARTERLY. Subscriptions to these magazines may be taken in combination with RADIO-CRAFT at reduced Club rates. Write for information.

Copyright 1932. GERNSBACK PUBLICATIONS, INC.

Published by
TECHNI-CRAFT PUBLISHING CORPORATION

Publication Office: 404 No. Wesley Ave., Mount Morris, Illinois

Editorial and Advertising Offices
 96-98 Park Place, New York City

Chicago Advertising Office
 737 North Michigan Avenue, Chicago, Ill.

Western Advertising Office
 220 No. Catalina St., Los Angeles, Calif.

L. F. McCLURE, Chicago Advertising Representative

LOYD B. CHAPPELL, Western Advertising Representative

London Agent: Hachette & Co.,
 3 La Belle Sauvage, Ludgate Hill, E.C. 4

Paris Agent: Hachette & Co.,
 111 Rue Renumer

Australian Agent: McGill's Agency,
 178 Elizabeth St., Melbourne

OPPORTUNITIES *are many* for the Radio Trained Man

Don't spend your life slaving away in some dull, hopeless job! Don't be satisfied to work for a mere \$20 or \$30 a week. Let me show you how to get your start in Radio—the fastest-growing, biggest money-making game on earth.

Jobs Leading to Salaries of \$50 a Week and Up

Prepare for jobs as Designer, Inspector and Tester—as Radio Salesman and in Service and Installation Work—as Operator or Manager of a Broadcasting Station—as Wireless Operator on a Ship or Airplane, or in Talking Picture or Sound Work—HUNDREDS of OPPORTUNITIES for a real future in Radio!

Ten Weeks of Shop Training

We don't teach by book study. We train you on a great outlay of Radio, Television and Sound equipment—on scores of modern Radio Receivers, huge Broadcasting equipment, the very latest and newest Television apparatus, Talking Picture and Sound Reproduction equipment, Code Practice equipment, etc. You don't need advanced education or previous experience. We give you—RIGHT HERE IN THE COYNE SHOPS—the actual practice and experience you'll need for your start in this great field. And because we cut out all useless theory and only give that which is necessary you get a practical training in 10 weeks.

TELEVISION *and* TALKING PICTURES

And Television is already here! Soon there'll be a demand for THOUSANDS of TELEVISION EXPERTS! The man who learns Television now can have a great future in this great new field. Get in on the ground-floor of this amazing new Radio development! Come to COYNE and learn Television on the very latest, new-

est Television equipment. Talking Picture and Public Address Systems offer opportunities to the Trained Radio Man. Here is a great new Radio field just beginning to grow! Prepare NOW for these wonderful opportunities! Learn Radio Sound Work at COYNE on actual Talking Picture and Sound Reproduction equipment.

All Practical Work At COYNE In Chicago

ALL ACTUAL, PRACTICAL WORK. You build radio sets, install and service them. You actually operate great Broadcasting equipment. You construct Television Receiving Sets and actually transmit your own Television programs over our modern Television equipment. You work on real Talking Picture machines and Sound equipment. You learn Wireless Operating on actual Code Practice apparatus. We don't waste time on useless theory. We give you the practical training you'll need—in 10 short, pleasant weeks.

Mail Coupon Today for All the Facts

H. C. LEWIS, President
Radio Division, Coyne Electrical School
500 S. Paulina St., Dept. 42-8H Chicago, Ill.

Dear Mr. Lewis:— Send me your Big Free Radio Book, and all details of your Special Offer.

Name.....

Address.....

City.....State.....



Many Earn While Learning

You get Free Employment Service for Life. And don't let lack of money stop you. Many of our students make all or a good part of their living expenses while going to school and if you should need this help just write to me. Coyne is 32 years old! Coyne Training is tested—proven beyond all doubt. You can find out everything absolutely free. Just mail coupon for my big free book!

H. C. Lewis, Pres. RADIO DIVISION Founded 1899
COYNE Electrical School
500 S. Paulina St., Dept. 42-8H Chicago, Ill.

SEND NO MONEY--

Clip and mail to us the coupon below. We will send you either one or both books through the Express Company for your inspection. You have the privilege of keeping or returning them.

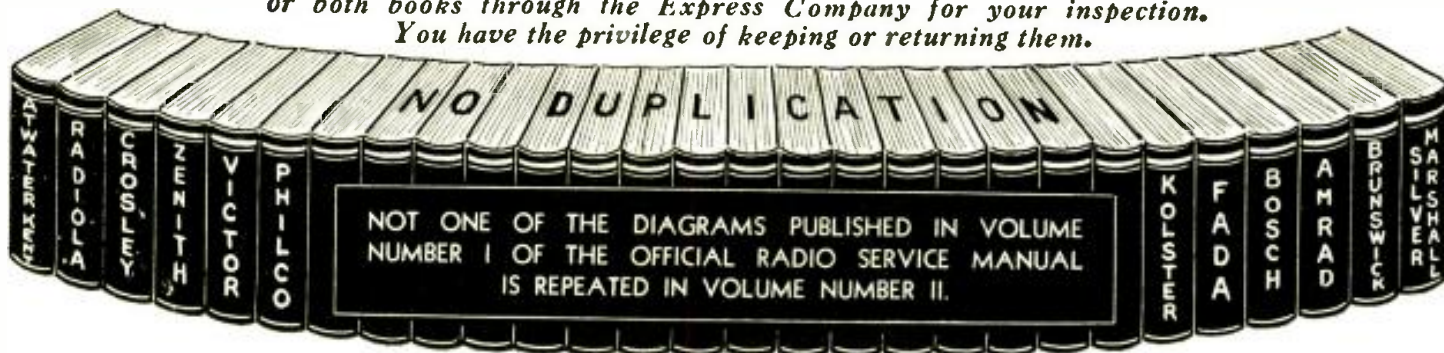

NOT ONE OF THE DIAGRAMS PUBLISHED IN VOLUME NUMBER I OF THE OFFICIAL RADIO SERVICE MANUAL IS REPEATED IN VOLUME NUMBER II.

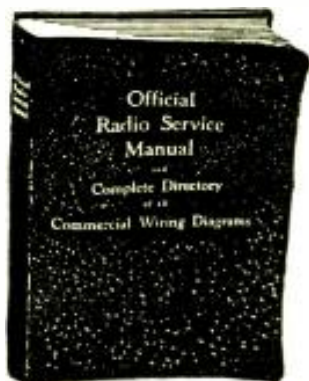

Volume I, 1931 Edition



Volume II, 1932 Edition

If you want a complete set of all Radio Diagrams, you must have both volumes in your file

Both volumes of the OFFICIAL RADIO SERVICE MANUAL will give you the most complete set of circuit diagrams ever published for the Radio Industry. Every Radio Service Man and Dealer should have them available for immediate use in his business. Professional set-builders and amateurs will find them instructive and helpful.

Briefly outlined below are the "high spots" that are to be found in the 1931 Manual—the first complete radio service manual ever to be published. Over twenty-seven thousand copies of this edition were sold to members of the radio industry. This assures you of its importance to those engaged in radio and how valuable it is to them.

Partial Contents

Wiring diagrams of radio sets manufactured since 1927, and many earlier ones of which there is any record elsewhere.

650 pages of helpful radio-servicing material.

Complete course of instruction for Radio Service Men, dealers, manufacturers, jobbers, set builders and amateurs.

(Here are but a few of the subjects covered in the special course of instruction).

- | | |
|------------------|----------------------------|
| Amplifiers | Power-Supply Systems |
| Antennae | Radio Phonograph Equipment |
| Automotive Radio | Resistors |
| Condensers | Short-Wave Sets |
| Detectors | Speakers |
| Eliminators | Tubes |
| Meters | |

Get Supplements FREE with the NEW 1932 MANUAL

There is so much new material in this Manual, that a Service Man or dealer would be lost without it when called to service a set. Information about new models which have been on the market only a few weeks are contained in this book. The 1932 Manual makes the service kit complete.

The 1932 Manual contains a Full Radio Service Guide and a Complete Directory of all 1931-1932 Radio Receivers, also models of older design. Everyone in the Radio business should have a copy. Send for yours today!

Partial Contents of Volume II

A step-by-step analysis in servicing a receiver which embodies in its design every possible combination of modern radio practice; it is fully illustrated and thoroughly explained. It is the greatest contribution to the radio service field.

Chart showing the operation of all types of vacuum tubes, whether new, old or obsolete. An exclusive résumé of the uses of the Pentode and Variable-Mu Tubes and their characteristics.

Complete discussion of the superheterodyne and its inherent peculiarities. Also a special chapter on tools used on superheterodyne circuits. Schematic diagrams and circuits complete with color codings.

Important chapters on commercial aircraft radio equipment; new data on commercial short-wave receivers and converters. Servicing and installation of public address systems and talking machine equipment.

Standardized color-codings for resistors. Operation of old and new testing equipment; tube voltmeters, output meters, oscillators and aligning tools.

A full section on Midget radios—their design, circuits, and types. How to service them most economically.

Hundreds of schematic diagrams of older radio receivers which have never been published.

Blank pages for recording notes, diagrams and sketches; these pages are transferable to any part of the book.

Coupon page for free questions and answers.

\$4.50 Complete with Supplements

Mail Coupon TODAY!

\$5.00 Complete with Supplements

650 PAGES

(Complete with Supplements)

Over 1,500 Diagrams, Charts and Illustrations

Flexible, Looseleaf Binder, 9 x 12 inches

GERNSBACK PUBLICATIONS, Inc. RC-1
96-98 Park Place, New York, N. Y.

Please send me for FREE inspection the books I have checked below. I understand that I may examine them carefully, and should I decide to keep them, I will pay the full cost, plus the few cents for carrying charges. This offer is good only in the U.S.A.

- Volume I, 1931 Manual, with Supplements, \$4.50
- Volume II, 1932 Manual, with Supplements to be mailed Free every 60 days, \$5.00
- BOTH BOOKS FOR \$9.00

NAME

ADDRESS

CITY..... STATE.....

OVER 1,000 PAGES

(Including Supplements)

Over 2,000 Diagrams, Charts and Illustrations

Flexible, Looseleaf Binder, 9 x 12 inches



ZEESEN
Germany

The ONLY



J. O. A. K.
Japan

RECEIVER that dares to promise daily 'round the world Performance

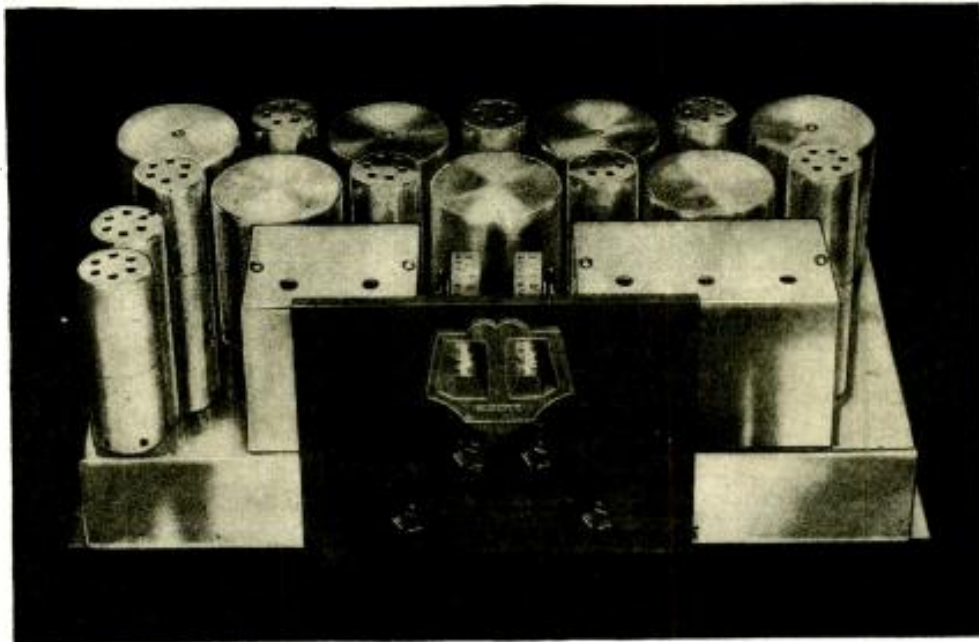

**From all over the world
come letters like these**

Excellent Program From Germany

"I have received with ample volume Rome, Italy; FYA, France, its three wave lengths; G5SW, England; ZEESEN, Germany; and half a dozen HK's from South America, not forgetting VK2ME, Australia. I was particularly pleased with the excellent reception from Zeesen, Germany."
F. S., New York City, N. Y.

Wished He Knew a Dozen Languages

"If I knew a dozen different languages I could have put them all to good use today. At 10:30 A. M. today I tuned in a French station and stuck with it until 11:00 A. M. when they quit after playing a phonograph record entitled 'Marseilles.' I received two Spanish stations I could not identify. Another station that sounded very much like Chinese, also went by the board. I was well repaid for my patience when I tuned in 12RO, Rome. Here was real reception—volume great enough to fill an auditorium, clear as a bell, no fading and no static at all. I held this station from 1:30 to 3:50 and heard every word uttered although I did not understand much of the language. Their signal was coming in very strong until 5:30 P. M."
S. M., McKeesport, Pa.

Indo-China Every Morning

"I get F31CD, Indo-China, every morning from six to eight our time and enjoy their program very much as it is very clear. Can also tune in stations in South America nightly."
F. L. F., Boise, Idaho

Italy and France All Week

"I have picked up these two stations all last week—12RO, Rome, Italy; FYA, Paris, France, from 2:30 P. M. until 5:00 P. M. with tremendous volume. I was able to listen to a program from England from 3:00 to 4:30 P. M. Sure was good reception. I can also get Spanish and South American stations."
A. M., Louisville, Ky.

- HEAR**
Radio Transmission from
- 1 Foreign Broadcast Stations
 - 2 Airplanes in flight
 - 3 Amateur phones
 - 4 Transatlantic phones
 - 5 Ships at sea
 - 6 Police departments
 - 7 Code stations all over world
 - 8 Domestic Stations

Out of the maze of radio claims and counter-claims—one FACT is outstanding. *The Scott All-Wave not only claims ability to tune in stations clear 'round the world, but presents undeniable proof of its world-wide prowess.* Then it crowns proof of range with proof of regularity—thereby establishing the Scott All-Wave as a 15-550 meter receiver you can depend upon to bring the whole world to your ears whenever you choose.

Here's the proof: During the last 8 months every bi-weekly broadcast (excepting three) put on the air by VK3ME, Melbourne, Australia—9,560 miles from Chicago—has been received here, recorded on disc and verified. You can hear these recordings at the Scott laboratories any time you wish. You

can also hear records made of reception from Japan, France, Germany, England, and South America; reception picked up by a Scott All-Wave right here in Chicago. In other words, you can have ACTUAL PROOF of this receiver's ability before you buy it! And if you came here to the Scott laboratories you would see why the Scott All-Wave can promise daily 'round the world performance—and why all Scott All-Wave Receivers are identical in capability.

The reason, of course, is advanced design and precision work—every step of the job actually done in the laboratory and to strict laboratory standards. And every receiver actually tested on reception from London and Rome before shipping!

Get the only receiver that can promise daily 'round the world performance, and live up to it. Write now for full particulars of the Scott All-Wave. You'll be agreeably surprised at the most reasonable price.

The E. H. SCOTT RADIO LABORATORIES, INC.
(Formerly Scott Transformer Co.) 4450 Ravenswood Ave., Dept. C42 Chicago, Ill.

*In a class by itself—
—alone comparison.
The Scott All-Wave
is the unchallenged
champion of the
radio world.*

SCOTT

ALL-WAVE

15-550 METER

Superhetrodyne

THE E. H. SCOTT RADIO LABORATORIES, INC.
4450 Ravenswood Ave., Dept. C42, Chicago, Ill.

Send me full particulars of the Scott All-Wave 15-550 meter Superhetrodyne.

Set Builder Dealer DXer

Name.....

Street.....

Town..... State.....

Build Your CUSTOMERS

THE Revolutionary

STENODE

The Receiver That Is NOISE FREE

on SHORT WAVES or BROADCAST

A STENODE demonstration will create more new custom set prospects than any radio receiver ever did before. People listen in amazement when they hear stations free of background noises and absolute silence between stations. When you tune out heterodynes and whistles and stations STAY IN strong and crystal clear, owners of all other sets gasp in astonishment. The former chief of wireless research of the British Royal Air Force, Dr. James Robinson has given an entirely new principal to radio in STENODE.

By the STENODE principal the highest selectivity ever attained as well as unprecedented tonal range is now made possible. All engineers agree that it is impossible with ordinary super-heterodynes.

STENODE amplifies signals most and static least. That's why YOU want to build an 11 tube STENODE to work with a SHORT WAVE adapter when it is not used to log and listen with enjoyment to more broadcasters than can be heard on any other type of radio. STENODE selectivity is 5 to 1 greater than that of so called 10KC Supers. The noise does not get in along with the high audio frequencies, and the STENODE reproduces perfectly higher frequencies than ever heard on any other receiver giving

500% BETTER SELECTIVITY
1000% MORE FREEDOM FROM NOISE
INFINITELY BETTER QUALITY



STENODE selectivity curve makes 10KC selectivity, so-called, look like broad tuning.

STENODE selectivity is compared, at left, to that of ordinary receivers. All background noise is contained in outer curve. Stenode's curve, shaded, contains but 1-10 the total noise.



STENOTUBE. Only one required in each Stenode. This heart of the Stenode circuit consists of a quartz crystal ground to 175KC frequency and mounted in tube form for easy handling. Standard UX socket base. Price \$15.

Made in England

None genuine without the inventor's signature.

James Robinson

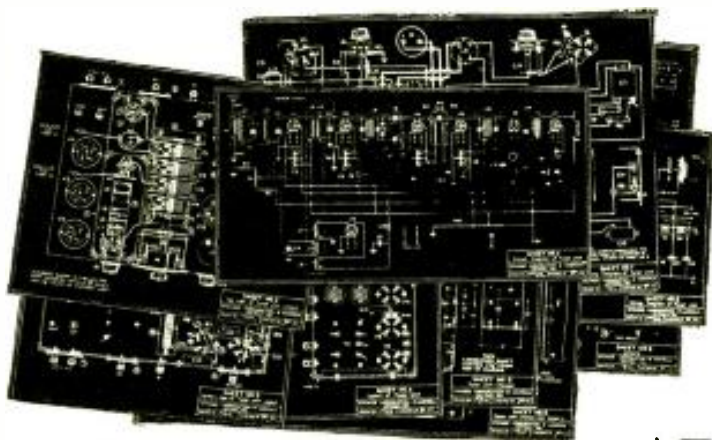

9 Blue Prints - Data Book - Direction Book Now \$5

Increased demand for Stenode Data Book, Instruction Book and Blue Prints permits our cutting former price in half. Those who have already sent in full price will receive our check for \$5. We are not interested in making profit from our engineering service. Our profits come solely from Royalties paid us by our licensees.

GERNSBACK PUBLICATIONS, Inc.
 98 Park Place, New York, N. Y.

Enclosed find Money Order, Check, for \$..... Please forward me STENOTUBE, BLUE PRINTS, DATA BOOK and DIRECTION BOOK for building STENODE.

(Make all checks payable to Gernsback Publications, Inc.)

Name

Street

City State

The STENODE opens up new fields for short-wave and television work, as well as broadcasting. Full details of all sorts of applications are given in the STENODE Data Book. Nine full-sized diagrams show where to place every part. How to make every connection is clearly told in STENODE Book of Directions. Your finished STENODE will put you into a new field of radio. Fill in and mail the coupon with your money order for the biggest value ever offered custom set builders.

STENODE CORP. OF AMERICA
 GERNSBACK PUBLICATIONS, Inc.
 98 Park Place New York, N. Y.
SOLE SELLING AGENTS

IF IT ISN'T A STENODE IT ISN'T A MODERN RECEIVER

LEGION offers SERVICE MEN and DEALERS

Exclusive TERRITORIAL RIGHTS

Representatives everywhere are making big money with this most beautiful line of midget and console quality receivers. . . . The manufacturer protects your locality for you. **ALL BUSINESS FROM THAT TERRITORY IS YOURS.** . . . The line is the most complete ever offered and includes five and six tube T.R.F. sets, six tube superheterodynes, four tube short-wave adapters, and nine tube all-wave combination receivers. **EVEN A MOST COMPACT AND SIMPLIFIED AUTOMOBILE SET WILL SOON BE READY.** Our complete television model is now in the course of construction. No matter what others may offer, you can be in a position to present something for less. . . . Write on your business letter-head or send us your business card. Only one representative selected for each territory. Be the first in your locality.



4 Tube Short Wave Converter.
 Uses 1-27; 1-21; 1-51; 1-80. Triple Switching Arrangement. No plug-in coils. Full-vision dial with travelling light. Special two-toned Walnut cabinet. Adapter connected to any receiver makes it a superheterodyne on short waves. Power supply is self-contained unit. Used on AC or battery operated receivers. Smooth tuning by means of high ratio tuning dial. Height 11½", Width 13½". Depth 9½". AC Model, \$14.25 less tubes. COMPLETE WITH ARCTURUS TUBES \$16.25.

Model 6A (above).
 Uses 2-24's; 2-35's; 1-47; 1-80. 110 Volts AC. 50 to 60 Cycles. Ultra-sensitive Dynamic Speaker. Tone Control. Hum Control. Full-vision Dial. Ball-bearing Condensers. Cabinet of selected art grained American Walnut. Height 18", Width 15", Depth 9". Weight 18½ lbs. AC Model, \$16.75 less tubes. COMPLETE WITH ARCTURUS TUBES. \$20.25. DC Model also.



Model 5B (above).
 Uses 2-35's; 1-21; 1-47; 1-80. 110 Volts AC. 50 to 60 Cycles. Height 16½", Width 11". Depth 9". Round arch model with two-toned American Walnut cabinet. Full-vision dial with travelling light indicator. Dynamic Speaker. AC Model, \$14.25 less tubes. COMPLETE WITH ARCTURUS TUBES \$16.75. DC Model also.
Model 5A has same characteristics as 5B but cabinet is of painted top design and dark American Walnut finish. AC Model, \$14.25 less tubes. COMPLETE WITH ARCTURUS TUBES \$16.75. DC Model also.



3 OTHER FEATURE MODELS

MODEL 6SA SUPERHETERODYNE.

Uses 2-51's; 2-24's; 1-47; 1-80. Circuit design exclusively our own—sensitivity of any nine tube receiver. Ultra-sensitive Dynamic Speaker. Tone Control. Hum Control. Full-vision dial. Ball bearing condensers. Cabinet of selected art grained American Walnut. Height 18", Width 15", Depth 9". Weight 25 lbs. AC Model, \$18.75 less tubes. COMPLETE WITH ARCTURUS TUBES \$21.75.

9 TUBE ALL WAVE COMBINATION.

Uses 3-51's; 2-24's; 1-27; 1-17; 1-80. This Super Superheterodyne has two full-vision dials with triple switching arrangement. No troublesome plug-in coils. Everyone can enjoy simplified tuning on all wave bands. Even a child can operate successfully. Tuning by six variable condensers (1 midget). Can be had in midget type cabinet or console. Height 19", Width 18", Depth 10½". \$37.50 less tubes. COMPLETE WITH ARCTURUS TUBES. \$42.00. Weight 30 lbs.

LEGION RADIO MFG. COMPANY
 154 WEST 22nd ST. NEW YORK, N. Y.

TRIAL ORDERS ACCEPTED

ALL SHIPMENTS MADE WITHIN 24 HOURS.
 All Prices Net. F. O. B. New York City. C. O. D. Orders must be accompanied by at least 20% of total amount. Balance on receipt of merchandise. Make all money orders or checks payable to Legion Radio Mfg. Co.

Super Power

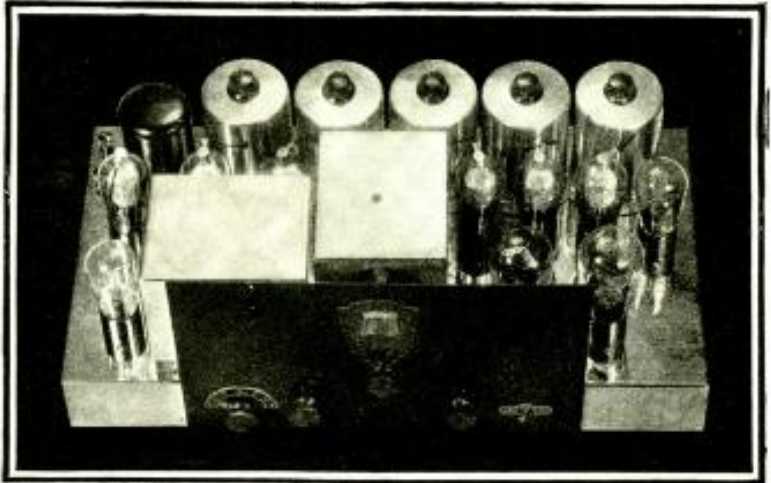

insures

World-Wide Performance- 15 TO 550 METERS-NO PLUG-IN COILS

Lincoln Super powered receivers are bringing in the finest reports we ever received. New short-wave stations coming on the air are reported to us from the Pacific Coast to New York City.

From California comes the following report: "I have picked up many SW stations. Sidney, Rio de Janeiro, Indo-China, Rome, Russia, Australia, Manila, Saigon, Mexico, Hawaii, Fiji Islands, and Siam. This is only a small list of stations picked up on the Lincoln. We tried out five other well known makes of widely advertised AC all-wave receivers, but found the Lincoln in a class by itself."

Selectivity

Many fine reports of extreme selectivity reflect the precision engineering of Lincoln equipment. A recent report from Staten Island, New York states: "Received WLW 700 K.C. WOR 710 K.C. WGN 720 K.C. CMK Cuba 725 K.C. Canadian 730 K.C. XER 735 K.C. WSB 740 K.C." Note the 5 K.C. separation of powerful stations.

A New Conception of Short-Wave Reception

The application of Lincoln's mighty power to the reception of short-waves produces truly amazing results. Stations half-way around the world come in with clock like regularity. Lincoln enthusiasts in the central states have repeatedly reported *broadcast* reception of

many trans-Pacific stations. The tremendous amplification of the highly engineered Lincoln circuit is always perfectly controlled in a channel less than 10 K.C. wide. A letter from Alaska reports reception of Mexico, Nebraska and Vancouver, B. C., all three stations 5 K.C. apart!

Full, Rich, Life-Like Lincoln Tone

Lincoln tone is a revelation of purity and fidelity. Lincoln experts have designed an audio system that, with either radio or phonograph pick-up input, delivers tone of astonishing richness and realism. Artificial tone compensators or control devices are not required to bring out the natural vivid tone of the living artist.

DeLuxe DC-SW-10, Battery Model, Is Extremely Efficient

The Lincoln DeLuxe DC-SW-10 is the battery model version of the famous DeLuxe SW-32 described above. Taking advantage of the new low drain 2 volt tubes, the DC-SW-10, when operated from an adequate battery source, provides exceptionally quiet, crystal clear reception of both broadcast and short-waves. This model, although intended for rural or un electrified areas, is finding increasing favor in congested city communities because of its absolute freedom from line noise and clear life-like tone quality.

Clip and Mail NOW!

**LINCOLN
DE LUXE-SW-32**

LINCOLN RADIO CORPORATION

Dept. RC-4, 329 S. Wood St., CHICAGO, ILL.

Please send descriptive literature to NAME.....

ADDRESS..... CITY..... STATE.....



"Takes the Resistance Out of Radio"

Editorial Offices, 96-98 Park Place, New York, N. Y.

THE BROADCAST SITUATION

By HUGO GERNSBACK

DURING the past year, a curious but important situation has developed in the broadcast field that deserves the thoughtful attention of the radio industry. When radio was young and took the country, nay the world, by storm, everyone seemed bent to shout radio's praises from the roof-tops. Loudest of all in praise, was the daily press, the newspapers vying with one another to give radio a tremendous amount of publicity. During the years between 1921 and 1926, the newspapers featured radio in a way nothing else had ever been featured before. Pages upon pages of space were given over by the newspapers, not only to current radio developments, but to programs as well. Many progressive newspapers in the large cities issued complete radio sections, some of them running regularly from 32 to 48 pages in length.

Gradually, as radio became better known, the newspapers particularly felt the need of curbing the publicity, and began to devote less and less space to radio. Most of them, however, still continued to carry radio programs as a seemingly necessary feature in the daily and Sunday editions; but when radio grew up, it became a threat to the newspapers themselves. The press, particularly in the smaller cities, began to devote less and less space to radio programs, until about a year ago; when action was taken by newspaper publishers to discontinue radio programs entirely. Indeed, in the middle part of 1931, the newspaper publishers got together and voted to discontinue radio programs entirely. There was a certain amount of justification in this; because the newspapers rightly claimed that most radio programs are nothing but advertising, and there would seem to be no reason for the press to sponsor such advertising.

Of course, not all radio broadcasting, as it is done today, is advertising. Many of the numbers on the air are purely "sustaining" features; in other words, such features are originated by the radio stations and for which they, themselves, must pay. When the National Broadcasting Company places the Metropolitan Opera on the air, or the Columbia network puts its weekly Overseas Programs on the air, the broadcasting companies themselves have to pay a tremendous amount of money for such features without receiving anything in return.

But the broadcast stations are in this nowise different from the newspapers. A newspaper must pay a large sum of money for its own sustaining features (which, of course, are the news and text of the paper) while the advertiser naturally pays for the advertisement. The parallel between broadcasting stations and newspapers is, therefore, quite close; and the newspapers rightly feel that there is no reason why they should give publicity, particularly to the sponsored advertising features that are now on the air.

The newspapers maintain that broadcasters should pay if they wish their programs published. But so far, there has not been any cooperation between broadcasters and newspapers with a view to publishing complete programs as a paid feature in the newspapers.

The broadcasting companies feel that even their sponsored features are still excellent entertainment; and that they should not be compelled to pay the newspapers for publishing such program service. The newspapers, on the other hand, can't see it that way; and more and more of them are cutting out radio programs or reducing the programs in such a way

that, in the average newspaper, one cannot compare a radio program published three years ago and one published today.

Of course, it is also true that a number of national advertisers, who are using the several broadcast chains, freely advertise the broadcast features in the newspapers in order to draw the readers' attention to such programs; but so far, there has not been a very large amount of such newspaper advertising.

The broadcasting companies evidently seem to think that radio broadcasting today has "arrived"; and that it is sufficiently powerful in itself to get along without the programs published in the newspapers.

Of course, another grievance, and perhaps the main grievance of the newspapers, is that the broadcasting companies are seemingly taking money out of their pockets. They claim that many national advertisers, who previously spent millions of dollars in newspaper advertising, have now quit the newspapers and gone "broadcast." The broadcasting companies counter this argument by saying that the newspapers haven't lost anything that they wouldn't have lost because of the depression. They say that, if there had been no broadcasting in 1931 and in 1932, the newspapers would not have any more advertising than they have now. They also maintain, with a good deal of logic, that broadcasting has created new business which indirectly comes back to the newspapers. Take, for instance, radio-set advertising, which could not exist if there were no broadcast stations. It is well known that the majority of radio-set advertising is done today through the newspapers.

All in all, it would seem that the honors are about even; and it is quite possible that in the future, broadcasters and newspapers alike can get along nicely without either suffering unduly.

Of course, the crux of the entire matter may perhaps be found in the reckless advertising now going out over the broadcast stations.

Many observers seem to feel that the broadcasters are "killing the goose that lays the golden eggs" by allowing too much advertising of a flagrant type to go on the air; and that, if there had not been so much "raw" advertising over the air, the newspapers would still be publishing radio programs.

No doubt radio broadcasting companies must shoulder their lot of the blame when it comes to this point, because unquestionably, the public is surfeited with the mass of injudicious advertising foisted upon it these days.

Broadcasting companies themselves are not in too happy a situation; because they must have an income, and that income can only be derived from the advertisers. No advertiser will spend the tremendous amount of money now required unless he gets something in return. Yet, many observers feel that the problem can still be solved if the advertising blurbs were not as "raw" as they are today. No one would object, if at the end of a program, a credit or by-line were given over the air in, for instance, such a way as: "This program has been given by the courtesy of the XYZ Company of Detroit."

It takes a tremendous amount of courage, and salesmanship of the highest order, to convince an advertiser, who spends a half a million dollars a year, that the present method of advertising over the air is detrimental to him. Yet, in time, I confidently predict a revolution in radio advertising that will make it possible for all concerned to be happy, and to get the most out of the wonderful instrumentality of radio.

THE Service Man who recognizes the need for a compact R.F. oscillator and tube tester, which is well within his financial means, should follow the description given by the author. Complete construction details, including that for the adapters necessary to test special tubes, are included. It should prove especially interesting to the man who is constructing his first tester. It may be built for less than ten dollars.

Many Service Men will have a voltmeter on hand which may be substituted. The meter used in this particular instance reads about 14 ma. full scale. The multiplier resistance was difficult to remove, so it was left in place. It gives some protection to the meter in case of an accidental overload. Since the resistor in the meter was about 500 ohms, a 100-ohm shunt was used to increase the meter reading to approximately 85 ma. Exact adjustment of the shunt size is unnecessary. No definite meter range is required. The tester is calibrated by testing a set of tubes that are known to be up to standard.

No provision has been made in the unit for a 175-ke. oscillator, since it is felt that in any case where such an oscillator is needed for aligning a superheterodyne, the set should be taken to the shop where a more precise oscillator should be available. However, should the constructor so desire, he may include a larger coil at a slight increase in bulk and switching complications.

Figure 3 illustrates the adapters for testing screen-grid tubes and pentodes. They are made from Pilot sockets and cut-down tube bases.

Since most of the parts for this outfit were supplied from the junk box, it was built at a total cost of less than \$10.00. When used in connection with a standard set analyzer, it has proved thoroughly satisfactory for regular service work.

Using the Tester

An examination of the diagram will reveal the presence of two sockets, one for four- and the other for five-prong tubes. To test a four-prong tube, all that is necessary is to insert it in the left-hand socket, close SW.4 and SW.3, first being sure that the filament switch is set at the correct tap. To change the scale of the milliammeter, close SW.2. For a mutual-conductance test, all that need be done is to close push button SW.1; this changes the bias on the tube which, of course, results in a change of plate current.

For testing heater-type tubes, they are inserted in the right-hand

socket of the tester; the test procedure is exactly the same as outlined above.

Figure 3 illustrates three types of adapters which may be used with this tester when four-element and pentode tubes are to be tested. At A, an adapter is shown for testing the '22 types; at B, an adapter for '24 type tubes; and at C, a pentode adapter. The four-prong adapter is inserted in

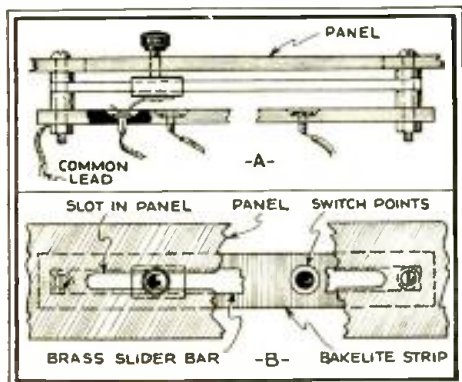

Fig. 2

At A, a side view of the slider arrangement and at B, a section view.

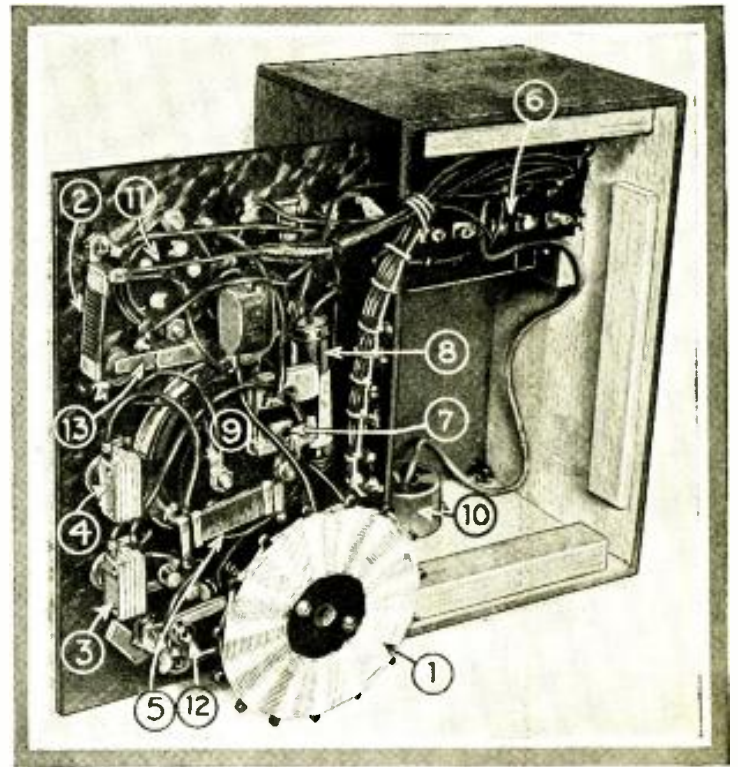

Fig. B

At (1) the oscillator coil; (2) R4; (3) SW2; (4) SH4; (5) R1; (6) power transformer; (7) C4; (8) R3; (9) milliammeter; (10) power socket; (11) 5-prong socket; (12) tuning condensers; (13) SH1.

the four-prong socket and the five-prong adapter in the five-prong socket in the tester.

A valuable feature of this tester is the oscillator. By opening switch SW.4, the tube that is being tested starts to oscillate, and

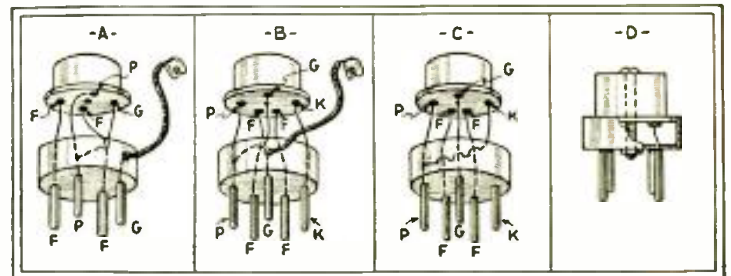

Fig. 3

At A, the adapter for testing four-prong screen-grid tubes; at B, the adapter for testing five-prong screen-grid tubes; at C, the pentode adapter; the assembled adapters look like that shown at D.

the new plate current may be read on the milliammeter M. In superheterodyne receivers, it is imperative that the oscillator be capable of producing oscillations over the entire broadcast band. To do this, all that is necessary is to vary the position of the three-point tap switch and note the plate-current reading while doing so. If the current changes appreciably while changing from one tap to another, then the tube is a poor oscillator and should be replaced.

By keeping a tube in the tester itself, and varying the position of the three-point tap switch, it is possible to use this tester as a modulated R.F. oscillator for aligning tuning condensers. It will be noticed that the plate voltage is obtained directly from the A.C. line, and therefore the plate voltage is modulated at the same frequency as the supply line—which in most cases is 60 cycles.

If a spider-web coil is not available for the oscillator, then a standard broadcast coil (about 60 turns on a 2-in. diameter tube) may be used. The tickler may be wound with about 30 turns of the same size wire adjacent to the secondary. It is not absolutely essential that the turns be exact, for the wavelength may be closely adjusted by the tuning condensers if so desired.

The experimenter should have no trouble in constructing this very versatile tester.

The LATEST Radio Tubes



Fig. A

Photograph of the new general-purpose pentode.

In this issue, four new tubes are described by the author. A new general-purpose pentode; a new '27; a new mercury-vapor '80; and a new power tube suitable for transmitting and receiving. Men who desire to keep abreast of new developments in the radio tube field should follow the descriptions given each month by Mr. Martin.

By LOUIS MARTIN

VARIETY is the spice of life." The man who was genius enough to originate the above expression certainly must have had the 1932 radio-tube field in mind when he thought of the adage. Just when and where these new tubes are to be used and to which junk heap the "old" ones are to be relegated, remains to be seen.

We have but one consolation, and that is the fact that the tubes illustrated here are merely variations of existing models. In the February issue of RADIO-CRAFT there was discussed a new R.F. variable-mu pentode. The tube as described was originally designed for automotive work, and for that reason the tube shown in Fig. A was designed. It is a pentode (not variable-mu) and is suitable for detection and amplification in both A.F. and R.F. circuits. In all probability it will replace the '24 which is now used so extensively.

In the following paragraphs, there will be described the characteristics of this new general-purpose pentode.

Technical Data

Figure 1 illustrates a family of plate voltage—plate current curves of the new tube. They are similar to those of the '24 except that the "dip" is removed by the addition of the fifth element. In Fig. 2 are shown control-grid voltage—plate and screen current curves. The sharp rise makes them suitable for detection. Last but not least, we have, in Fig. 3, curves showing the variation of amplification factor, mutual conductance and plate resistance with control-grid volts.

The smooth variation of the constants of this tube clearly indicate the advances made in tube design during the past few years. It is a wonder that such a tube was not brought out some years ago. We eagerly await the reception that this tube is sure to cause.

Operating Potentials

The operating characteristics of this tube are as follows: Filament potential, 2.5 volts; control-grid potential, -3.0

volts; screen-grid potential, 90 volts; plate potential 250 volts. Filament current, 1.1 amp.; plate current, 4.7 ma.; screen-grid current, 1.25 ma. The amplification factor is 1300, the plate resistance 1.1 megohms, and the mutual conductance 1170 micromhos.

This tube is especially adaptable for short-wave work since its plate—control-grid capacity is .0005 mmf., its control-grid—filament capacity 3.0 mmf., and its plate—filament capacity 6.8 mmf.

Here's hoping for a long and prosperous life!

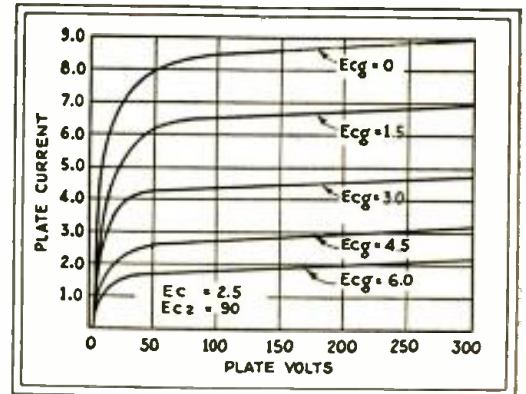

Fig. 1

Family of plate voltage—plate current curves of the new general-purpose pentode.

The New '27

Our friends, the tube manufacturers, announce a new type '27. The characteristics are the same as the old model except that the filament current is 1 ampere instead of 1.75 amperes, the present value. The plate of the new model is solid, which, it is claimed, considerably reduces hum. This tube, of course, may be used instead of existing models without any changes in circuit design—provided half-way-decent power transformers (low regulation) are used. The glass bulb is very much smaller, which should help midget-receiver manufacturers to some extent. It is shown in Fig. B.

A Mercury-Vapor Rectifier

One of the bad features of present-day rectifiers is their poor regulation. The voltage drop in the tube for reasonable load-current drains is excessive and the variation in output voltage with varying load currents is too great. This feature is especially unsuitable for class B amplifiers where the variation in current drain is great. To obviate the above difficulties, a new mercury-vapor full-wave rectifier has been developed. A photograph of this new tube is shown in Fig. C. It is made to replace the '80 type rectifier. A double-choke filter is recommended with 4-mf. filter sections.

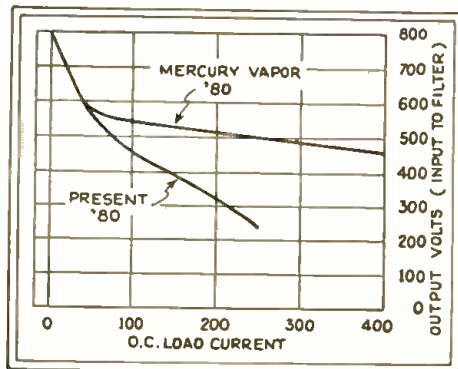

Fig. 4

Voltage-regulation curve of the mercury-vapor '80. Compare this with the curve of the present '80.

The filament is rated at 2.5 volts at 3.0 amperes. The R.M.S. volts rating per plate is 475—950 volts for the entire tube (it being a full-wave rectifier). The average D.C. output is 125 ma. and the peak output is 400 ma.

The mercury in the tube ionizes with about 15 volts R.M.S. on each plate and, from then on, the internal voltage drop is very small. Fig. 4 shows a regulation curve of the mercury vapor '80 compared with the present type. The change in output voltage (input to the filter) is small. The load current is the D.C. actually supplied by the tube and the size of the glass bulb is the same as the '27 described above. In view of the obvious advantages of this tube, it should be welcomed as a duck welcomes water.

A New Voltage Amplifier

At this time, one of the leading tube manufacturers announces a new voltage amplifier designated as the type '41.

It is a three-electrode, high-vacuum tube which resembles the '10 in general appearance and filament characteristics but has a high amplification factor. It is designed primarily for use as a voltage amplifier in resistance- or impedance-coupled circuits. In addition to this use, the '41 may also be employed to advantage in amateur transmitters as an oscillator, a crystal-controlled oscillator, a radio-frequency power amplifier, or a frequency doubler.

Characteristics and typical operating conditions for different applications of the '41 are given in the accompanying table. For convenience in presentation, the information has been tabulated in four divisions. The first division, "General Data," includes information common to all applications. The other three divisions,

under the headings of "Class A," "Class B," and "Class C" service, cover operating conditions for specific applications. These three classifications are the accepted ones used by radio engineers for broadly identifying tube applications.

Class A Service is employed in the operation of well-designed audio - frequency and radio-frequency amplifiers of radio receivers. For this use, fidelity of signal reproduction is of prime importance. However, fidelity is obtained at the expense of power output and at relatively low efficiency. The '41 as a Class A amplifier, is operated under such conditions that its dynamic characteristics are essentially linear.

Class B Service is employed in radio-frequency power amplifiers and in balanced or push-pull modulators of radio telephone transmitters. It is also finding application for power output stages of some of the more recent designs of radio receivers. For these uses, large power output is obtained without distortion and with good efficiency. However, to obtain this large power, a large exciting grid voltage is required. The '41 as a Class B amplifier is operated under such conditions that, with no exciting grid voltage applied to the tube, the plate current is very small. Under these conditions when excitation voltage is applied, only the least negative half of this voltage produces power output.

Class C Service covers those applications where tubes are employed as oscillators or audio-frequency power amplifiers for transmitters. For these uses, very large power output with high efficiency is of primary consideration. However, this high output is obtained at the expense of considerable harmonic distortion. This distortion introduced in the output may be an advantage, as, for example, in the case of frequency doubler circuits. In the case

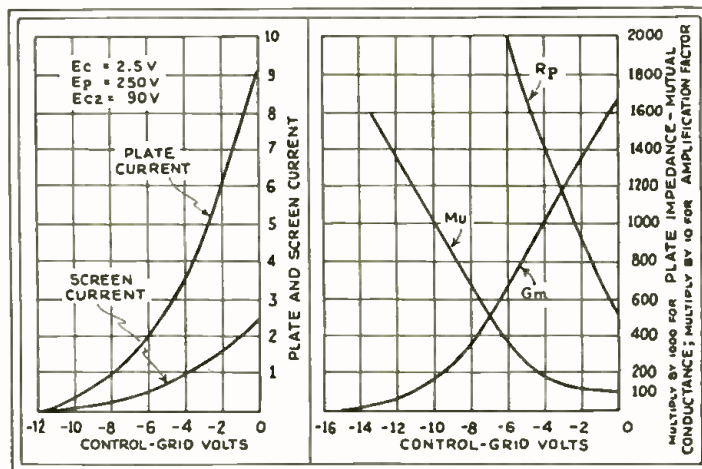

Fig. 2 Characteristics of the pentode.

Fig. 3 Curves showing the variation of μ , G_m , and R_p , with control-grid voltage.

of a transmitting power output stage, the harmonics are removed from the fundamental frequency by means of suitable filters. The '41 as a Class C amplifier is operated under such conditions that the grid is biased well beyond the point at which plate current starts. Under these conditions, when excitation voltage of sufficient

magnitude is applied, large peaks of plate current are obtained in the output of the tube.

Ratings, characteristics and typical operating conditions for the '41 are as follows:

General Data

Filament voltage (A.C. or D.C.), 7.5 volts; filament current, 1.25 amperes; amplification factor, 30. Direct interelectrode capacitances: plate to grid, 8 mmf.; grid to filament, 5 mmf.; plate to filament, 3 mmf.

Class A Service

Maximum operating plate voltage, 425 volts; maximum plate dissipation, 12 watts.

Typical Operation

Plate supply voltage, 425, 1000 volts; grid voltage, -5.8, -9.2 volts; load resistance, 250,000, 250,000 ohms; plate resistance, 63,000, 40,000 ohms; mutual conductance, 450, 750 micromhos; plate current 0.7, 2.2 milliamperes; peak grid swing, 5.8, 9.2 volts; output voltage (5% 2nd harmonic), 126, 225 volts.

Class B Service

Maximum operating plate voltage, 450 volts; maximum D.C. plate current (unmodulated), 50 milliamperes; maximum plate dissipation, 15 watts; maximum R.F. grid current, 5 amperes.

Typical Operation

Plate voltage, 350, 450 volts; grid voltage (approx.), -5, -8 volts; D.C. plate current (unmodulated), 43, 36 milliamperes; peak power output, 12, 16 watts; carrier output, modulation factor 1.0, 3, 4 watts.

Class C Service

Maximum plate dissipation, 15 watts; A.C. (R.M.S.) plate voltage, 450.

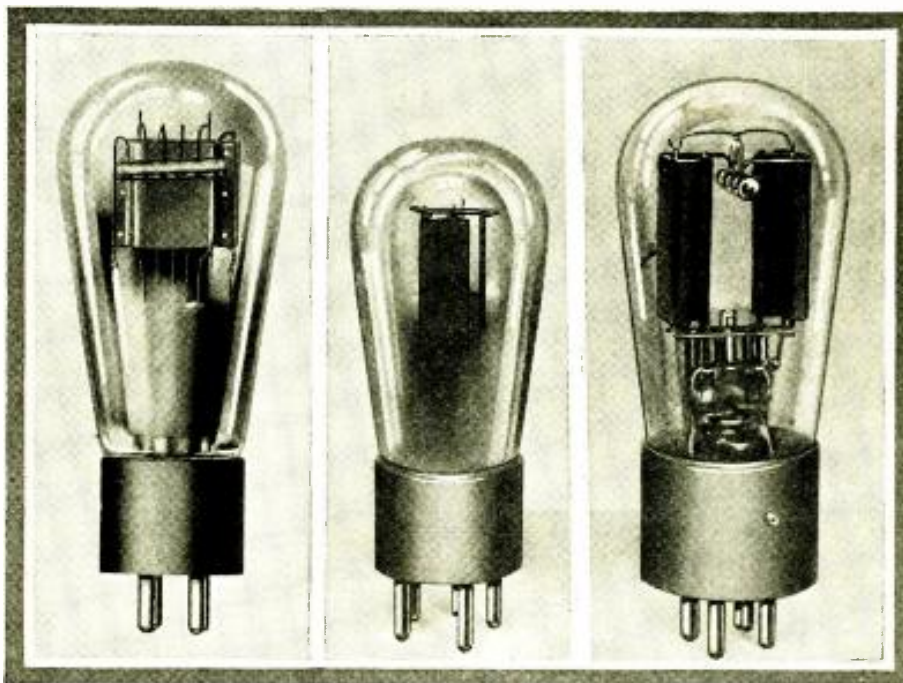

Fig. D The new '41 amplifier.

Fig. B The new '27.

Fig. C The new mercury-vapor '80.

The Latest in RADIO EQUIPMENT

MOLDED BAKELITE CAPACITORS

TWO new types of molded bakelite mica condensers for transmitting- and receiving-circuit applications are illustrated in Fig. A.

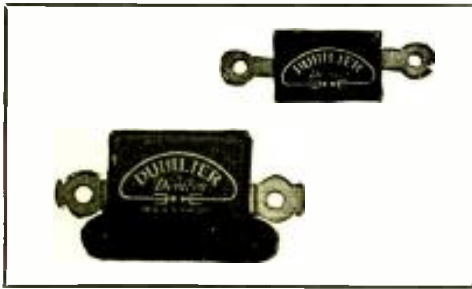

Fig. A

Left, the type 3, and right, the type 4 molded bakelite condensers.

The type 3 condenser covers various capacities from .00004- to .004-mf. The terminals are side strips with holes for mounting and tabs for soldered wire connections. The case measures 1 1/4 x 9/16 x 3/8 ins., while the over-all length, including terminals, is 2 3/16 ins.

The type 4 condenser covers various capacities from .00004- to .025-mf. The molded case is of radically new design, with integral lugs through which mounting screws, for flat mounting, may be slipped. If the condenser is to be mounted upright, small metal brackets are provided, held in place by rivets slipped through the integral mounting lugs. The case measures 1 1/4 x 1 x 7/16 ins. The over-all length, including terminals, is 2 1/4 ins.

The above units are manufactured by the Dubilier Condenser Corp.

NOVEL AUTOMOTIVE REMOTE-CONTROL UNIT

IN Fig. B is illustrated a commercial remote-control unit as used in many makes of manufactured automotive receivers. The manner in which this type of unit may connect into the circuit is illustrated in the schematic circuit of the Universal automotive receiver, Fig. 1.

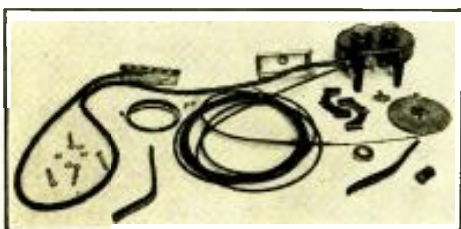

Fig. B

Component parts of the Carter radio control unit.

Although the standard cable length is 10 ft., a control cable can be supplied which will operate satisfactorily up to 30 ft. The cable may have three, four, five, or seven wires, as the circuit requires; the 3-wire cable is standard.

The manufacturers of this "steering-post control" for automotive receivers, Carter Radio Co., require the following data: length of control cable from edge of control case to center of condenser shaft on set; diameter of condenser shaft; schematic circuit of set in which the control is to be used; resistance of the volume-control resistor; direction of condenser rotation; size, 5- or 10-amp. fuse, of fuse block.

A COMPACT AUTOMOTIVE RECEIVER

IN Fig. C is illustrated a well-designed automotive receiver of small-space type. This is the Universal Auto-Radio Model No. 66. As the schematic circuit, Fig. 1, indi-

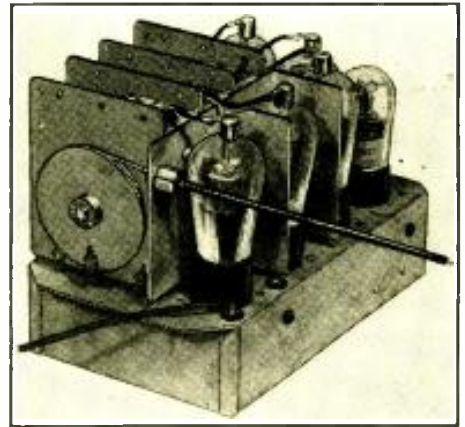

Fig. C

The chassis of the Universal auto receiver.

The compact condenser gang selected for these models is manufactured by General Instrument Co.

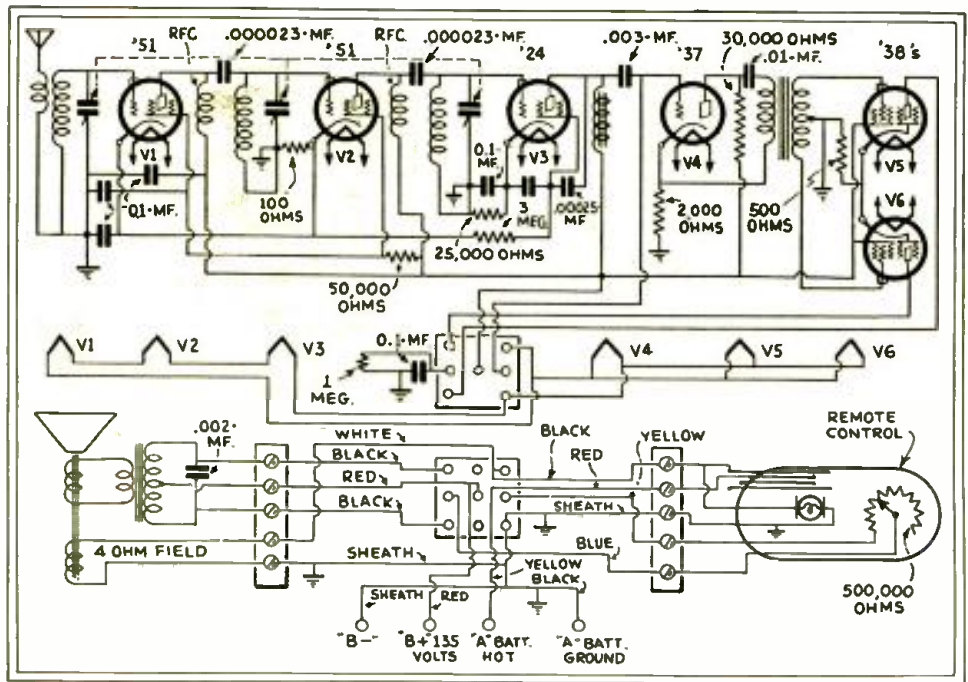

Fig. 1

Schematic circuit of the Universal Auto-Radio Model 66 receiver. It employs variable- μ tubes, a push-pull pentode output stage and a Carter remote-control unit illustrated in Fig. B.

icates, it incorporates two variable- μ tubes as R.F. amplifiers, a screen-grid detector, a type '37 first-stage A.F. tube, and in the output circuit two type '38 tubes in push-pull.

A Carter remote-control unit (described in another portion of this department) is incorporated in the 6-tube "De Luxe" model, which differs from the 5-tube "Standard" model only in the quality of the dynamic reproducer and the use of twin-pentodes.

The total "A" current consumption is 2.5 A.; the "B" drain is 32 ma. Due to the use of an automatic volume-control type of circuit, a relatively even output volume is maintained with an input signal variation of 1,000 to 1, it is said. Only two leads from the "B" supply are required, intermediate potentials being obtained by the use of dropping resistors. Although the usual tuning range is 550 to 1500 kc., special models are available for police service in the 1710- to 2420-

ke. band. The chassis is suspended on rubber inside the metal case.

The rugged construction and exceptional ease of installation and replacement of these receivers, which are manufactured by Universal Auto-Radio Corp., recommend them to automotive set specialists.

THE No. 171 "RECORDOVOX"

IN past issues of RADIO-CRAFT, in the "Sound Recording" department, there have been described several home-recording devices; the newest one is illustrated in Fig. D.

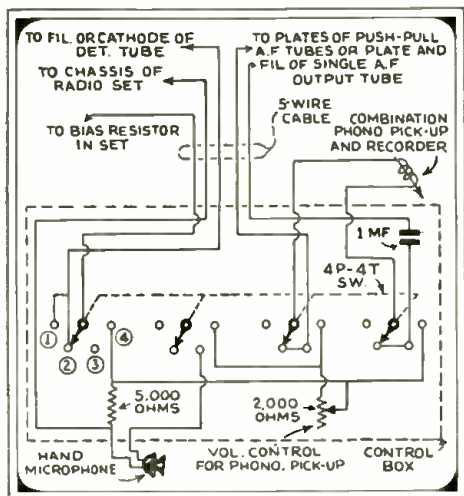

Fig. 2
Schematic circuit of the Recordovox.

Known as the Patent No. 171 "Recordovox," this versatile attachment may convert any old-style phonograph into a high-grade musical instrument that will electrically reproduce home records as well as all regular commercial records. It also allows for the making of home records of voice, music, or radio programs.

Provision is made for the use of a hand microphone, through which the set owner can record his or her voice, or insert his own announcements into radio programs for the amusement of unsuspecting guests.

Permanent connection to the radio receiver is made without disturbing any existing wiring, all interconnections for the various operations being made by the turn of a knob, as shown in Fig. 2.

A combination head replaces the usual tone arm on the phonograph, the sound being reproduced through the audio amplifier and loud-speaker of the radio receiver.



Fig. D
Component parts of the Recordovox.

The control box, neatly finished in aluminum and measuring only 6 x 3 x 1 3/4 ins., bears two knobs, one for control of the volume of phonograph reproduction, and the other for shifting between radio, recording, reproducing and announcing.

Proper connection to the radio chassis is easily made with the aid of adapters which fit under two or three of the tubes. No tools are required for this work.

The Recordovox is manufactured by the Paent Electric Company.

A COMMERCIAL MODEL RADIO-PIANO

IN Fig. E is illustrated the "Lyric Radio—Wurlitzer Student Piano Combination." Of course, a radio-piano combination is not an innovation—custom-set builders have been building up such arrangements for many years. It is believed, however, that this marks the first announcement of a commercial instrument of this nature, ready for the consumer trade, and designed to meet the requirements of small homes and apartments where the desire for both radio and piano can be fulfilled. This combination fits into the space of the ordinary console-type radio receiver, and thus conserves considerable space.

The piano is the very latest design, a petite Student model. Red cases with red keys to match, green cases with green keys, blue cases with blue keys, and black and gold cases with amber keys are predominant colors. The panel effect is heightened by shading. The piano measures approximately 40 x 21 x 41 ins. high.

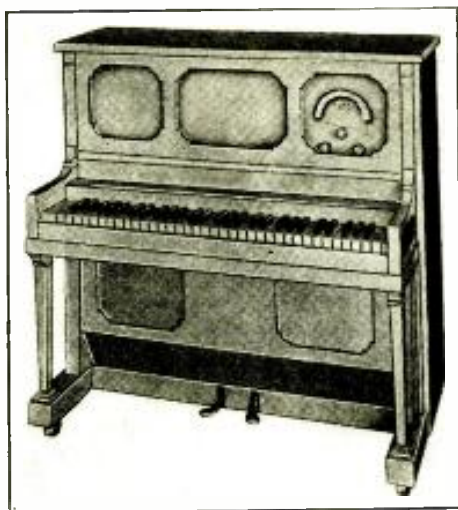

Fig. E
The new Wurlitzer radio-piano combination.

The Lyric radio chassis is mounted in the lower right side of the bottom panel and is connected with the control panel by means of rods. The control panel is in the upper right corner of the top panel; the reproducer is in the lower left corner of the bottom panel and, due to the color-matching of the grille, is practically invisible.

The Radio-Piano Combination is manufactured by the All-American Mohawk Corp.

AERIAL TOWERS

TO meet the demand for a simple, effective mast-design suitable for use under average requirements, there has been de-

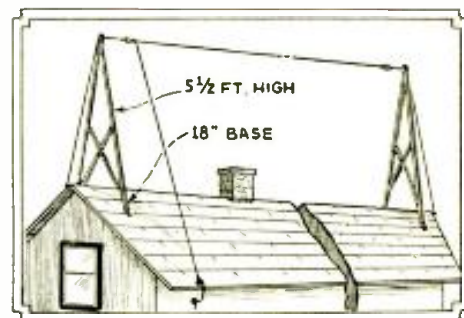

Fig. 3
An erected LeBourg radio antenna.

veloped the heavy iron-wire construction illustrated in Fig. 3. These masts are sold in pairs; each one is topped by a porcelain insulator around which the guy wire and antenna are fastened.

These masts, which measure 1 1/2 x 5 1/2 ft., are manufactured by A. LeBourg.

THE MODEL 868 PHOTO-ELECTRIC CELL

A NEW photo-electric cell, suitable for use in sound movies in the home, and for many novel experiments, has recently been announced. As in other photo-electric cells, this unit consists, as can be seen by reference to Fig. F, of a large light-sensitive cathode and a small anode.

The cathode of the 868 is a semi-cylindrical sheet of metal and is coated with a thin film of caesium. The anode or collector consists of a small wire placed in the axis of the cathode surface. A small amount of gas is used in this tube to produce high sensitivity.

It is sensitive to light over the entire visible spectrum, as may be seen by reference to Fig. 4. The high sensitivity in the infra-red zone makes the cell very sensitive to light which is emitted by tungsten-filament lamps. Ordinarily, the cell requires further amplification which may be secured by a suitable resistance-coupled amplifier.

The following are the ratings and characteristics of the new tube, which is manufactured by the RCA Radiotron Company, Inc., and E. T. Cunningham, Inc.:

- Anode Supply Voltage—90 volts maximum;
- Anode Current—20 microamperes maximum;
- Static Sensitivity—45 microamperes per lumen;
- Dynamic Sensitivity at 1000 cycles—40 microamperes per lumen;
- Dynamic Sensitivity at 5000 cycles—38 microamperes per lumen;
- Load Circuit Resistance—0.1- to 5 megohms;
- Maximum Over-all Length—4 1/4 ins.;
- Maximum Diameter—1 3/16 ins.;
- Window Area of Cathode—0.9-sq. ins.;
- Base—Small Four-Prong.

(Continued on page 622)

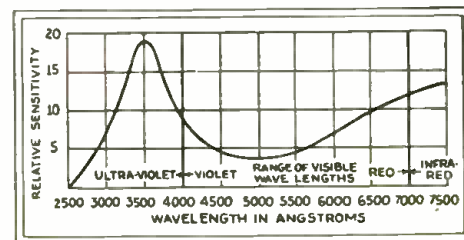

Fig. 4
Color response curve of the 868 P.E.C.



Fig. F
The 868 P.E.C.

The RADIO-CRAFT

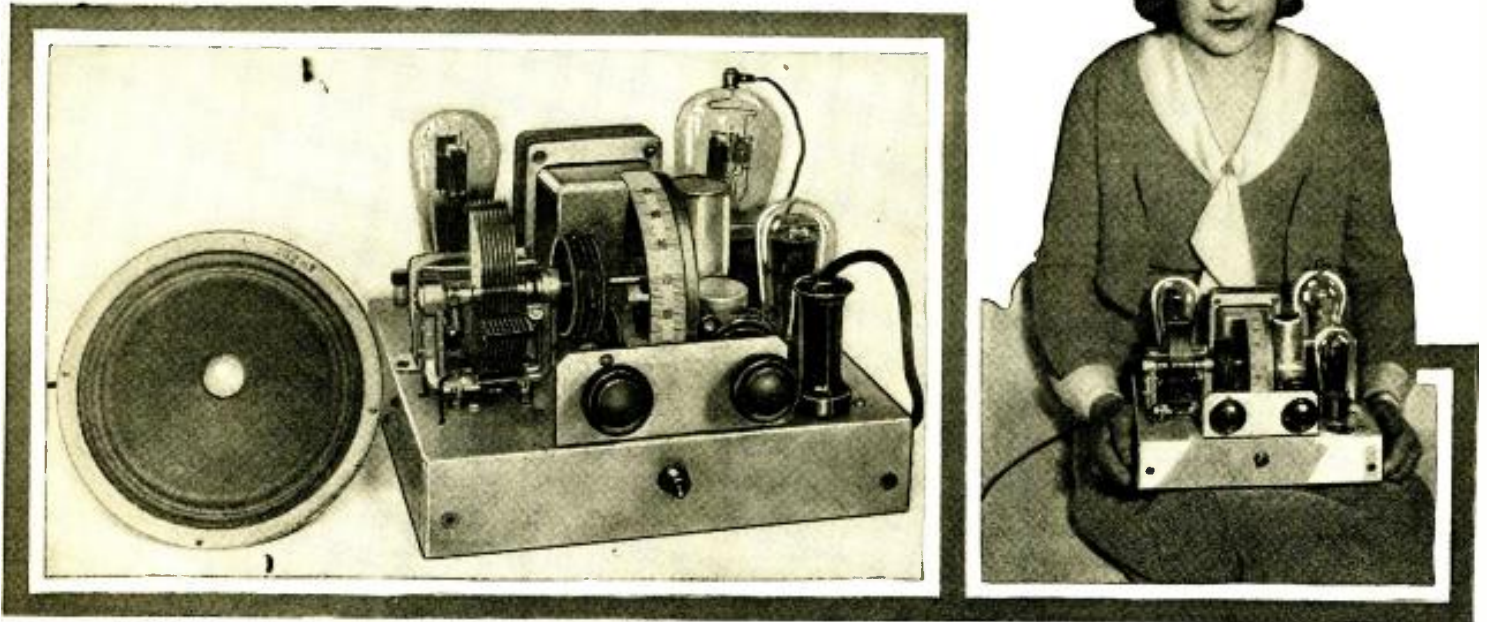

Fig. A. The completed chassis of the RADIO-CRAFT "2-Tube" Receiver is shown at the left; at right, its relative size is indicated.

VARIOUS methods have been tried from time to time to build small, powerful receivers. As a general rule, as far as amplification was directly concerned, most of the amplification was accomplished in the audio-frequency section of the receiver. Thus, we first had the crystal detector followed by an audio-frequency amplifier, then the non-regenerative and the regenerative detector followed by the audio amplifier. The difficulties encountered in the design of such receivers were, by necessity, overcome through a compromise between many factors relative to the design. One of the greatest of the controlling factors has always been the low order of efficiency of the triode tube itself; this efficiency being defined as the ratio of A.C. power developed to the D.C. plate dissipation. We discussed this in our announcement of the "Triple-Twin" tube in the February, 1932 issue of RADIO-CRAFT.

An examination of the curves shown in the article will immediately convince one of the possibility of this tube's use in a small receiver. A receiver that would at once be powerful as to volume and sufficiently sensitive for consistent local reception. In the experimental work on the application of this tube to a simple receiver, the input section was arranged as a detector and, to increase sensitivity, regeneration was added. This, however, did not allow great enough voltage to be impressed on the input grid to deliver sufficient power from the output section.

By introducing a regenerative detector and coupling to the input of the "Triple-Twin" tube through a transformer, a powerful, simple, and inexpensive receiver may be constructed. With this in mind, we set about building such a receiver which is described in the following paragraphs.

It might be mentioned that this receiver

By the Engineering Staff of RADIO-CRAFT

compared very favorably as to volume with a midget receiver consisting of two tuned variable-tun R.F. stages, followed by a '24 detector, resistance coupled to a '45 output tube.

Construction

In view of desired compactness, the receiver was designed with the power-supply unit on the same chassis. However, the receiver may be constructed in two units, in order that the "Triple-Twin" may be used with some other tuner. If this construction is adopted, and it is desired to supply the tuner with power from the power-amplifier unit, it will be necessary to employ a larger transformer than that recommended herein.

The aluminum chassis is made from a plate of aluminum 1/16-in. thick, 13 ins. wide, and 14 ins. long. The four corners are then cut out and the various bends are made. After the chassis is formed into shape, the positions of the holes to be drilled, including those for the wafer sockets and the transformer port, are then marked out on the chassis, after which they are drilled.

The support for the drum-dial mechanism is made from a piece of aluminum 2 1/2 ins. wide and 4 1/2 ins. long. Along one side, 1/2-in. from the edge, a line is marked, after which the edge is bent over at right angles. Two holes 1/2-in. in diameter are now drilled on centers which are 1 in. from each end and 1/2-in. from the unbent edge. Two small holes are drilled on the bent-over edge, 3/4-in. from each end in order that the plate may be mounted vertically on the chassis with screws and nuts as shown in the photographs, Figs. A and B.

After the chassis has been prepared, the

tuning coil is next made. This consists of a length of bakelite tubing 1 1/4 ins. in outside diameter and 3 3/4 ins. long. Beginning 7/8-in. from one end, 110 turns of No. 30 B. & S. wire are wound. The ends of the winding may be soldered to lugs which have been fastened to the ends of the tubing by small rivets, eyelets, or screws and nuts. Over the filament end of the 110-turn winding, the antenna primary is wound. This consists of 12 turns of the same size wire. The tickler consists of 25 turns of No. 28 B. & S. wire wound on bakelite tubing 1 in. in diameter. This coil is then inserted inside the tuning coil at the grid end. The end of the winding nearest the grounded end of the secondary should be connected to the plate of the detector, if all windings are in the same direction. The ends of the primary and secondary may be brought out to lugs on the grid end of the coil, while the antenna end of the primary should be brought out at the opposite end. The ends of the tickler may be brought out at either end, although it is more convenient to use the grid end.

Assembly of Parts

Next in order is the mounting of the parts on the chassis. The tube sockets are first mounted, followed by the mounting of the power transformer T2 and the chokes CH.1 and CH.2. The variable condenser is next mounted; this is accomplished by using long screws. In order that the drum dial shall have sufficient clearance from the top of the chassis, the variable condenser is mounted with 3/8-in. brass bushings, through which the constructor passes the mounting screws of the condenser. Next is mounted the drum-dial driving mechanism. This is fastened to the support plate with the flat-headed screws provided with the drum dial. The support plate is next fastened to the

"Triple-Twin" Receiver

LOUD-SPEAKER OPERATION!

HERE is a set that brings back the good old DX days as no set in recent years has done.

Here is a two-tube set (the rectifier tube is not counted) which will spin circles around the best four- to six-tube sets in use today.

The Editor recently tried this set in his home on Riverside Drive and in a single night was able to pull in, on a 40-foot antenna, the programs of practically every station East of Denver. Such stations as WBZ, Springfield, which, in his location is never received even with a Super, came in with regular loud-speaker strength. In a single evening, some 40 DX stations were logged, all being heard on the dynamic reproducer.

Local stations came in so loud that the small 6-inch dynamic was not able to carry the load and started to rattle. In volume, the reproduction of the set was as loud as that from a good 6-tube midget console set of a well-known make!

Here then, is the ideal receiver for the builder who wishes something ultra-new in a set that will be modern in 1933. We recommend it highly to set builders, and all those who want something out of the ordinary.



Fig. B

Underside view of RADIO-CRAFT'S set.

chassis. Next, the drum dial is placed in position. To do this, it will be necessary to extend the shaft of the condenser by loosening the set screws, after which the set screws are again tightened firmly.

The sensitivity-volume control R2 is next mounted in position. If care has been exercised, there will be just enough clearance between the dial and the variable resistance to allow the drum to pass freely. The photographs show a left-hand drum, but the above will hold true with the right-hand drum as well.

The power switch SW. is now mounted in the hole drilled in the front of the chassis, followed by the mounting of the audio transformer T1, and the bypass condensers C4, C5, and C9. Next is mounted the filter condenser C6, and the bias resistor R6. The two leads from the variable resistor R2 are soldered in place before the filter condensers C7 and C8 are mounted on the top of the chassis. The tuning coil is now mounted under the chassis in the position shown. The remainder of the parts are not mounted until the receiver is wired. The wafer socket provided near the front edge of the chassis is for connection to the midget dynamic speaker.

Placing the Receiver in Operation

To place the receiver in operation, it is first necessary to check the wiring in accordance with the circuit diagram. The voltages are next checked before the insertion of the tubes. After the tubes are inserted and the four-prong plug of the speaker cable plugged into the speaker socket on the chassis, the voltages are next adjusted. The voltages on the '27 detector should be between 22½ and 45 volts; this voltage is not critical, though a lower value tends to better control of regeneration. The voltage on the plate of the '95 tube should be 265 volts. The bias resistor R6 is next adjusted in the following manner: with the positive terminal of a 1000-ohms-per-volt voltmeter, or other suitable instrument, placed on the center tap of the filament winding, and the negative terminal to the chassis, the resistance is adjusted until the voltage is 17 volts.

The tap of the bias resistor is next adjusted. By keeping the positive terminal of the voltmeter on the center tap of the filament winding, and placing the negative of the meter on the tap of the bias resistor R6, the voltage is adjusted to 3 volts by shifting the tap on the resistor. It may be necessary to repeat the operation a few times until the voltages are correct. It will be noticed that by varying the voltage between the center tap of the filament winding and the tap on the bias resistor R6, a control of the amount of hum is secured.

List of Parts

- One Hammarlund, Type ML17, 350-mmf. variable condenser, C1;
- One Hammarlund, Type SWD-1 drum-dial;
- Two Aerovox, Type 200-S, 1-mf., bypass condensers, C4, C9;
- One Aerovox, 250-mmf. molded mica condenser, C2;
- One Aerovox, 500-mmf. molded mica condenser, C3;
- One Aerovox, Type 200-S, 4-mf. bypass condenser, C5;
- Two Aerovox, Type Hi-Farad electrolytic filter condensers, 4 mf., C6, C7;

- One Aerovox, Type Hi-Farad electrolytic filter condenser, 8 mf., C8;
 - One tuning inductance (described in article), L;
 - Two National, 60-ma., 30-henry chokes, unmounted, CH.1, CH.2;
 - One Thordarson, replacement type audio transformer, T1;
 - One Franklin midget power transformer, 85 watts, PT;
 - One Electrad Super-tonatrol, 0-10,000 ohms, tapered, R2;
 - One Electrad Tru-volt resistor, Type B, 500 ohms. with tap, R6;
 - One International resistor, metallized, 1 watt, 2 meg., R1;
 - One International resistor, metallized, 2 watt, 250,000 ohms, R3;
 - One International resistor, metallized, 2 watt, 12,500 ohms, R5;
 - One International resistor, metallized, 1 watt, 100,000 ohms, R4;
 - One Cutler-Hammer power switch, SW.;
 - One "Blan the Radio Man" aluminum chassis, 10 ins. long, 9 ins. wide, 2 ins. high;
- (Continued on page 622)

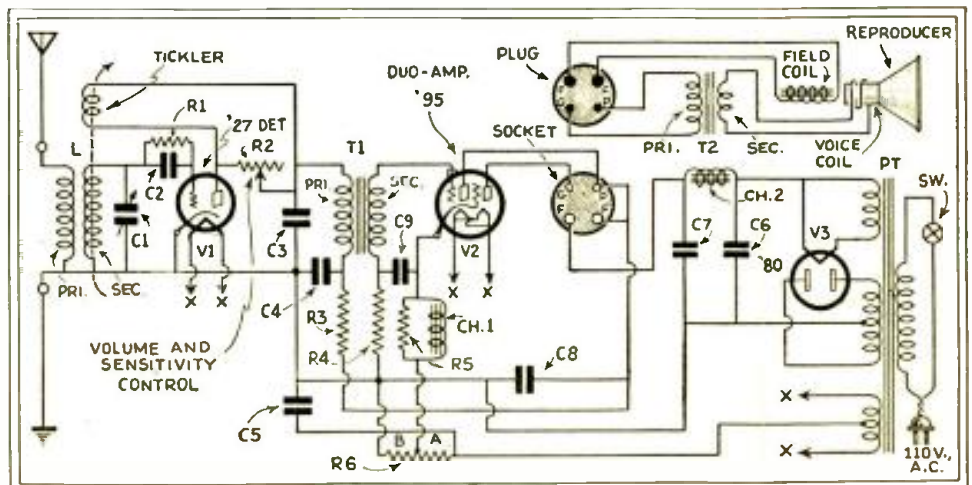
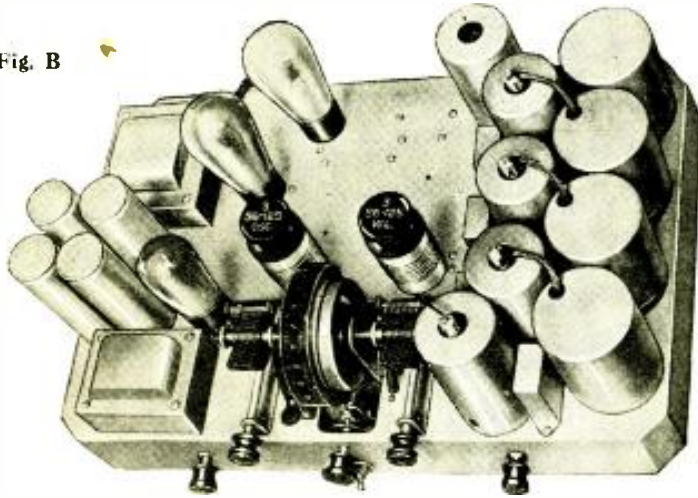

Fig. 1

Schematic circuit of the new "2-Tube" receiver; distant stations are received at loud-speaker strength. Tube V2 functions as a 2-stage direct-coupled A.F. amplifier; the first plate's load is composed of R5 and CH.1. The field coil of the dynamic reproducer forms one of the filter chokes. The position of the tickler coil is fixed; reverse its leads if regeneration is not obtained on the first tests.

The "Comet" All-Wave Set

Fig. B



By means of plug-in coils, this new receiver covers a wavelength range of 15 to 550 meters. A feature of the design is the use of a second-oscillator which makes convenient zero-beat reception of all stations, including CW code. The receiver's sensitivity figure is less than one microvolt-per-meter.

THE thoroughly captivating feature of radio has always been "DX." With the advent of short waves and their innate globe-circling characteristics, the fascination has become more stirring than ever. And now, especially so, with the recent development of an ultra-sensitive receiver.

This is the new Hammarlund all-wave superheterodyne, the "Comet," illustrated in Figs. A and B. The receiver not only fills the requirements for short-wave work, but for broadcast work as well.

The "Comet," an eight-tube model (Fig. 1), uses two '27's as oscillators, two '21's as detectors, two '35's (variable mu's) as I.F. amplifiers, a '47 in a resistance-coupled audio amplifier, and an '80 as a rectifier.

Features of the Receiver

The I.F. stage uses a band-pass tuning system to afford extreme sensitivity and selectivity with faithful reproduction throughout the entire audible range.

Another unusually interesting feature is the second-oscillator which serves a dual purpose. By putting this tube into play, and this is done by a switch on the instrument panel, distant stations on both broadcast and short waves can be located with utmost simplicity and, also, it enables the reception of CW signals (code) with ease.

* Hammarlund Mfg. Co.

By MARTIN W. LEWIS*

To facilitate precision tuning, the major tuning control is supplemented by two fool-proof mechanical verniers, one for each condenser, located on each side of the major control knob. Incidentally, the projection-scale method, which affords magnification of the scale indications, is used. This, of course, provides easy selection of stations.

For maximum efficiency throughout the entire wide range of frequencies which this receiver covers, special isolantite form plug-in coils are used, Fig. B. These permit complete coverage of all the bands, including broadcast. There are five sets of coils, two coils to a set, having the following ranges (in meters): 15-30; 28.5-62.5; 58.8-130; 120-273; and 240-550.

A new speaker has also been designed for use in this all-wave receiver; it derives all the necessary power for energizing its field coil from the set.

Discussion of Circuit

The superheterodyne has often been referred to as the "king" of radio receivers, chiefly because its circuit simplifies the problem of obtaining uniform R.F. amplification of almost any desired amount and, at the same time, affording a high order of selectivity which is also substantially uniform over a wide band of signal frequencies.

Since the advent of screen-grid tubes, gang condensers and elaborate shielding, R.F. amplification at frequencies within the

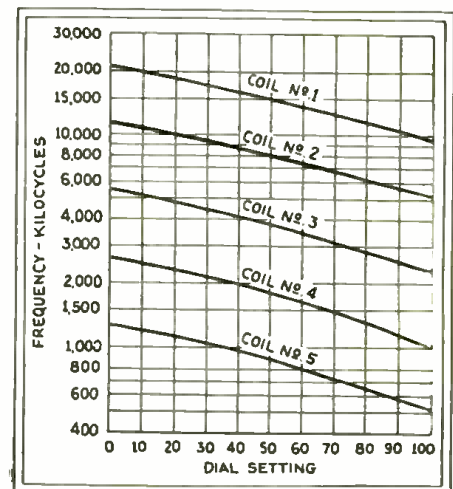

Fig. 6

Tuning ranges of the Comet's five coils.

broadcast band is easily accomplished. Therefore, the outstanding advantage of the superheterodyne at present is in the matter of selectivity. While this advantage is not negligible at the comparatively low frequencies of the broadcast band, its effect at the high frequencies involved in short-wave

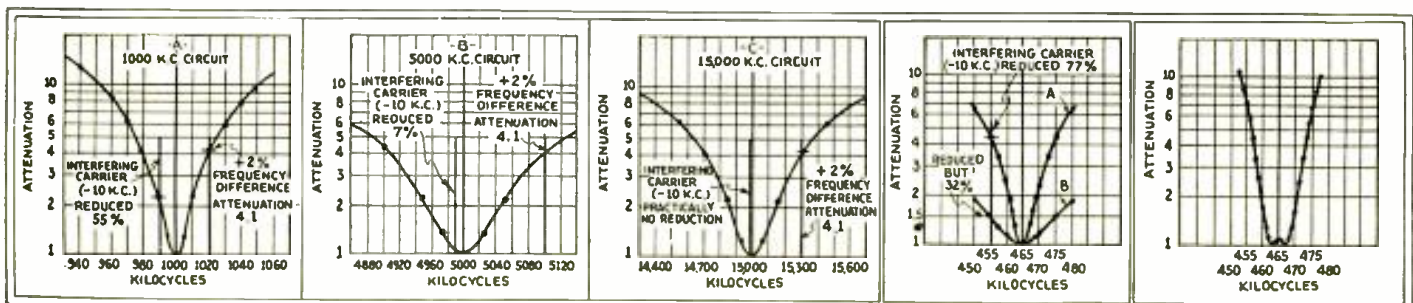

Fig. 2

At A, B and C are shown relative selectivity graphs.

Fig. 3

Stage selectivity.

Fig. 4

Amplifier selectivity.

reception is truly remarkable.

It can be shown that a series of tuned circuits possessing good discrimination between two signals on adjacent channels (say 1000 kc. and 990 kc.) must be of very high quality, as the percentage difference is only 1%. Assuming it to be possible to build a series of circuits of the same efficiency to operate, say, in the 10,000- to 20,000-ke. band, it would be practically impossible to separate two stations operating at 15,000 kc. and 14,990 kc. since the percentage difference is but 1/15 of 1 per cent.

This principle is clearly illustrated in Fig. 2. Curves A, B, and C represent the tuning characteristics of single tuned circuits resonant at 1,000 kc., 5,000 kc. and 15,000 kc., respectively.

The power factor of all three circuits is .01 (Q of 100), which is reasonably good for radio circuits. Since the power factor of all the circuits is identical, the selectivity of each must also be the same. This is shown by the amount of attenuation for frequencies 2 per cent greater than the resonant frequency, which is 4.1 in all three cases. However, the reduction of an interfering carrier 10 kc. below the resonant frequency is far from uniform and is substantially zero in the 15,000-ke. circuit.

With the superheterodyne principle, this difficulty disappears. By means of the local heterodyne oscillator, the 1000-ke. signal (which we shall assume to be the one desired) is changed to 465 kc. At the same time, the undesired 990-ke. signal is changed to 455 kc. and both signals are impressed on the intermediate amplifier. The intermediate amplifier then has the task of amplifying the 465-ke. signal (for which it is tuned) and reducing (or rejecting altogether) the 455-ke. interference. This is comparatively easy as the percentage difference here is 10/465, or over 2 per cent. The effective selectivity in this case has been more than doubled. This effect increases

rapidly with increasing signal frequencies.

Figure 3 illustrates very clearly the result of increased resistance in the intermediate coils. Curve A is the tuning characteristic of a single intermediate coil as used in the "Comet." Curve B is that of a coil of the same inductance having four times as much resistance. The loss of selectivity due to the higher power factor is considerable.

For this reason, the intermediate coils used in the "Comet" are wound with special "Litz" wire, resulting in a power factor of .01 (Q of 100). Six of these coils are used, two in each transformer, in the tuned plate-tuned grid hook-up. This provides six sharply-tuned, low-loss circuits in the intermediate amplifier. While this arrangement affords extreme selectivity, the double-tuned critically-coupled circuits result in a steep-sided response curve with a rounded top, thus minimizing the type of R.F. distortion known as side-band cutting.

Figure 4 shows the actual tuning characteristics of a complete I.F. transformer using two of the Litz-wound coils, each having a power factor of .01. While no over-all selectivity curves are available at this time, a fairly accurate idea of them is given by Fig. 5 which is a calculated curve of the selectivity of the complete intermediate amplifier based on the actual characteristics of one transformer as shown in Fig. 4.

Although it is obvious that a lower I.F. would afford even greater selectivity by reason of a further increase in the percentage frequency-difference, there is another consideration which makes a high I.F. desirable. All superheterodyne receivers are subject to an "image" interference which, stated briefly, means an undesired signal whose frequency difference from the desired signal is exactly equal to twice the I.F. used in the receiver.

It naturally follows that a high I.F. lessens interference from this source. A maximum spread between a desired signal and its



Fig. A
The Hammarlund "Comet" in a console.

image interference is especially important in short-wave reception. On the other hand modern design necessitates the use of an I.F. materially lower than that of any of the signals to be received. For these reasons, 465 kc. was chosen as the I.F. for the "Comet."

Figure 6 shows the tuning ranges of each of the five sets of coils. Ample overlap is provided, insuring complete coverage of the entire range of 14 to 550 meters.

The Filter System

A '24 type screen-grid tube is used as a first-detector or "mixing" tube.

The second-detector is also a '24A type screen-grid tube working as a plate-circuit (Continued on page 623)

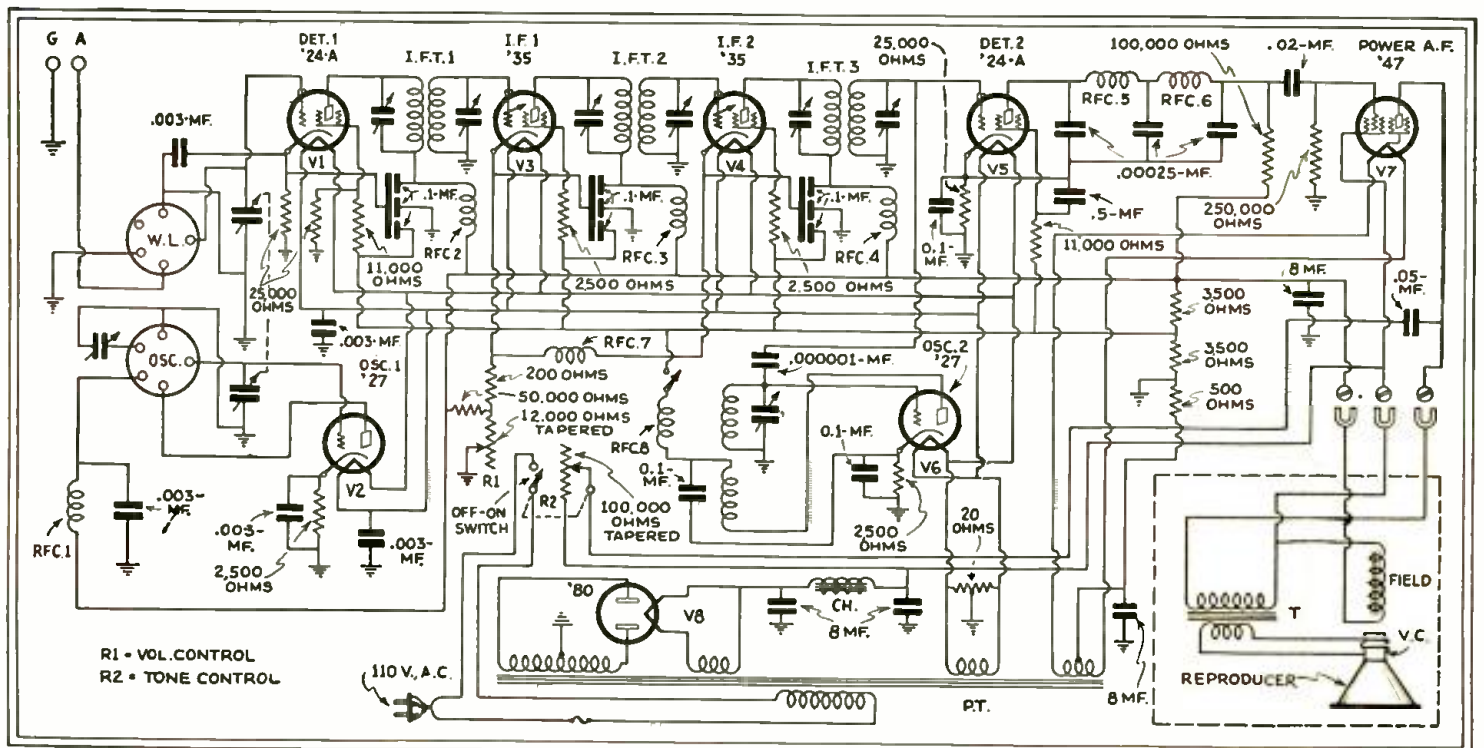

Fig. 1

Schematic circuit of the "Comet" superheterodyne receiver. The I.F. is 465 kc. Tube V6 is used for zero-beat reception of all signals.

I. F. Coil Design

The "how" and "why" of intermediate-frequency transformer construction

THE increasing interest in superheterodyne receiving circuits from the home constructors' and experimenters' angle has made more plaintive than ever that old refrain—"How many turns should I wind on an intermediate-frequency transformer?"

The author will endeavor to supply such information as is necessary to enable the builder to design and construct coils which will be as good as, if not superior to, any on the market.

A discussion of the advantages of a particular frequency, such as 175 kc., over that of, say, 45 kc., is not within the province of this article. There are many reasons set forth by engineers as to the respective merits of the various intermediate frequencies of their choice, but today we find that for ordinary broadcast reception the 175-kc. band has become more or less standard. For short-wave "superhets," other frequencies (some within the broadcast band) are used; so the tables which are given in this article, for those who are not so mathematically inclined, include all frequencies from about the center of the broadcast band to the old stand-by frequency, 45 kc.

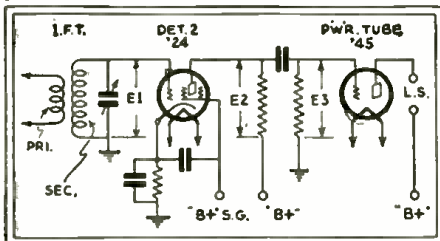

Fig. 1
Elementary circuit of a typical I.F. amplifier.

Three of the most important factors to be taken into consideration in the design of I.F. transformers are:

1. The sensitivity required to obtain the required power output from low signal inputs;
2. The degree of selectivity necessary per stage to give a satisfactory over-all selectivity in the receiver; and
3. Mechanical and cost considerations such as chassis size, coil-shield size, number of tubes, etc.

An examination of the factors listed above will lead us to believe that there is more to the design of an I.F. transformer than the mere selection of a coil with a given diameter and wire turns plus a resonating capacity.

Design Considerations

The logical way to design our coils is, first, to determine the required degree of sensitivity. If we know the total over-all gain required for a given output, we can ascertain the required gain per stage. We shall have a fair idea of the grid swings

By CLIFFORD E. DENTON

on successive stages at full power output, which will enable us to design our circuits for minimum tube distortion and maximum selectivity and stability. The solution of the

Any increase of voltage on the grid will be the cause of undesirable distortion and, of course, must be avoided. It is best to use R.M.S. values in calculating the various signal voltages, and as the R.M.S. voltage of 50 V. is $.707 \times 50 = 35.35$ volts, we find that the R.M.S. value which can be applied

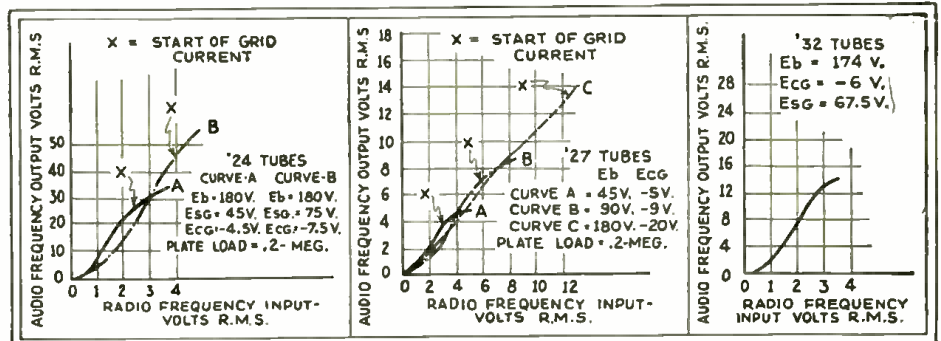

Fig. 2, left. Curves showing the possible gain that may be expected from a '24 tube.
Fig. 3, center. The same curves as in Fig. 2, only for a '27.
Fig. 4, right. Same as for Figs. 2 and 3 but for a '32.

1st factor listed will be a guidepost in the determination of factors 2 and 3.

Instead of using the level of 50 milliwatts output, we shall use the rated power output of the tube or tubes as indicated in the various tables supplied by tube manufacturers.

If the power tube selected is of the '45 type, the power output will be 1600 milliwatts at the maximum rated voltage. This means that if we want a power output of 1.6 watts (1600 milliwatts) to be fed into the speaker, the input signal voltage on the grid of the '45 must not be greater than 50 volts peak (the value of the grid bias).

to the grid of the '45 is 35.35 volts. Most radio sets today feed the audio output of the detector into the grid of the power tube by means of resistance coupling; in this case, the detector will have to deliver 35.3 volts to the grid of the output tube.

Preliminary Calculations

Figure 1 shows the circuit of a power detector, resistance-capacity coupled to the output tube, and we find that in the case of a screen-grid detector and a '45, E3 will be 35.35 R.M.S. volts. No gain can be expected from the resistance-capacity unit so

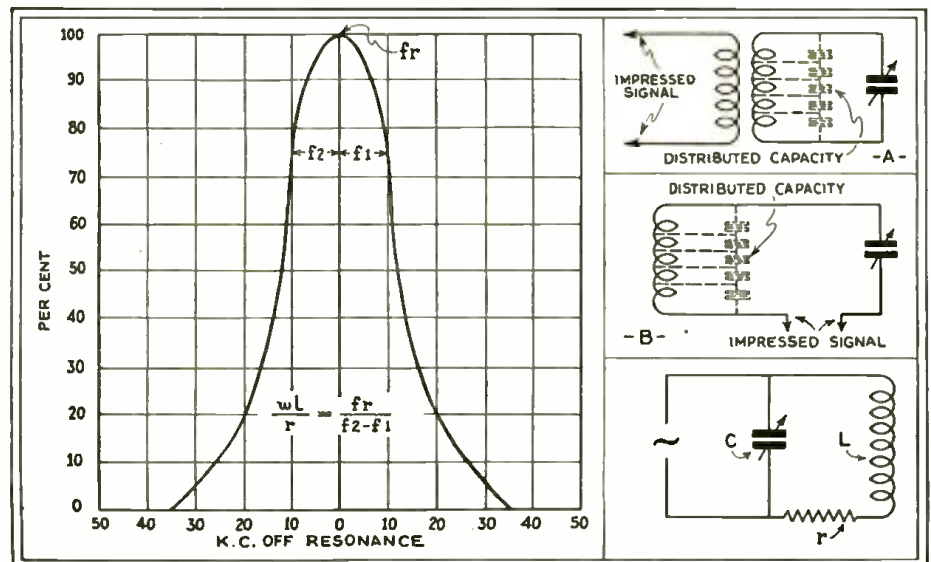

Fig. 6, upper right. Circuits illustrating the effects of distributed capacity.
Fig. 7, lower right. Circuit illustrating the effects of coil resistance on a tuned circuit.
Fig. 8, left. Curve showing how the "Q" of a coil may be computed.

that the voltage at E2 must also be 35.35 volts. Figs. 2, 3, and 4 show the possible audio output of three standard tubes used as second-detectors in "superhets." These curves show the A.F. output volts (R.M.S.) of the '24, '27, and '32 tubes plotted against the R.F. input volts (R.M.S.) and are very useful in view of the fact that they give us the required operating potentials for these tubes used as detectors and the required R.M.S. values of the incoming signals to "kick" the power tube. Figs. 2 and 3 also show the points where grid current will start due to overloading of the grid by the incoming signals.

Referring to Fig. 2, we find that a signal of 3.24 (R.M.S.) volts is necessary on the grid of the '24 detector to fulfil the requirements of the '45 for maximum power output. The signal on the grid should not exceed 4 volts R.M.S. or the grid will draw current, thus causing distortion. In the case of the '27, Fig. 3, we find that it would require an R.F. input of 12 volts to deliver an A.F. output of 13 volts. This tube will not satisfy the condition of maximum power output unless a high-primary-inductance A.F. transformer, with a turns ratio of at least 3.5 to 1, is used. A bad feature of such a tube is the fact that grid current starts to flow at about 12.5 to 13 (R.M.S.) R.F. volts. Under all conditions, it is advisable to work

R.M.S. volts on grid of detector

R.M.S. volts input from antenna
4 volts

$$\text{or } \frac{\text{R.M.S. volts on grid of detector}}{\text{R.M.S. volts input from antenna}} = 200,000 \text{ gain.}$$

As a certain amount of amplification can be, and is, obtained by one or more stages of conventional T.R.F. ahead of the modulator tube (first-detector), it is not absolutely necessary that the entire burden of amplification be borne by the I.F. amplifier. If there are two stages of T.R.F. ahead of the modulator, then there will be a voltage gain of about 1500 (assuming a gain of about 40 volts per stage) which must be considered in designing the I.F. amplifier. The reader will recognize the necessity of using pre-amplification before the modulator as this phase has been covered in many excellent articles on the subject.

Now, let us see just what the final figures will be with the added gain obtained in the pre-amplifier.

If the input to the receiver is .00002-volt and the pre-amplifier has a gain of 1500, then the input to the first I.F. transformer will be .00002 x 1500 or .03-volt. The 4 volts required by the detector, divided by the .03-volt input to the I.F. amplifier, will then be the voltage gain required by the I.F. amplifier, which is 133.3 volts.

TABLE I

"TURNS-PER-INCH" OF INSULATED WIRE								
P. & S. Gauge	DCC	SCC	DSC	SSC	Enm.	Enm. and SCC	SBC	
14	13.7	14.6	14.7	15.0	15.2	14.2	14.7	
15	15.0	16.2	16.4	17.0	17.0	15.8	16.5	
16	16.7	18.0	18.2	19.0	18.7	17.6	18.4	
17	18.5	20.0	20.0	21.2	21.4	19.5	20.6	
18	19.6	22.3	22.3	23.6	24.0	21.7	22.9	
19	22.5	26.0	25.2	27.0	27.2	24.2	25.8	
20	24.5	27.6	27.5	29.5	30.1	26.5	28.4	
21	27.5	30.8	30.8	32.8	33.6	29.6	31.6	
22	30.0	34.0	34.0	36.8	37.7	32.7	35.0	
23	32.7	37.8	37.5	40.7	42.3	36.1	39.0	
24	35.6	41.5	41.5	45.3	47.2	39.7	43.1	
25	38.6	45.7	45.7	50.3	52.9	43.7	47.9	
26	41.8	50.2	50.2	55.7	59.0	47.8	52.8	
27	45.0	55.0	55.0	61.7	65.6	52.1	58.1	
28	48.5	60.0	60.0	68.3	73.9	57.0	64.4	
29	52.0	65.5	65.5	75.4	82.2	61.9	70.6	
30	55.5	71.3	71.3	83.1	92.3	67.4	77.9	
31	60.0	77.3	77.3	91.6	103.0	72.8	86.3	
32	62.7	83.7	83.7	101.0	116.0	79.1	93.9	
33	66.3	90.3	90.3	110.0	130.0	85.6	103.0	
34	70.0	97.0	97.0	120.0	145.0	91.7	112.0	
35	73.4	104.0	104.0	131.0	164.0	98.8	123.0	
36	77.0	111.0	111.0	143.0	182.0	105.0	133.0	
37	80.3	125.0	125.0	155.0	206.0	113.0	146.0	
38	83.6	133.0	133.0	169.0	235.0	120.0	157.0	
39	89.7	140.0	140.0	181.0	261.0	128.0	172.0	

as various conditions develop which cause the gain of this portion of the circuit to vary over wide ranges. The sensitivity and output will be affected by the strength of the received signal, by the power output of the local oscillator, and by any change in operating potentials which may take place as the receiver is functioning.

The check for the correctness of the calculation can be made by multiplying the gain in the pre-amplifier by the gain in the I.F. amplifier; thus, 1,500 x 133.3 gives a value of 199,950.

Figure 5 shows a skeleton circuit with the voltages developed in the various circuits. Two stages of I.F. amplification are shown and, as each stage is not working at the maximum possible gain, the I.F. amplifier will be very stable and the coils easy to design.

If an actual condition exists where the gains and voltages are measured and found to be as indicated in Fig. 5, the volume (Continued on page 624)

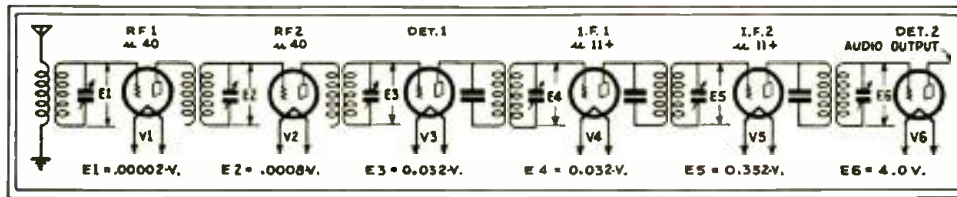

Fig. 5

An elementary circuit illustrating how a signal is amplified through an amplifier.

the tube at some value below that which causes the flow of grid current.

If it is desired to use a pentode as the output tube with a screen-grid second-detector, we find that an R.F. signal input of less than 2 volts will be sufficient to deliver a power output of 2.5 watts.

If push-pull circuits are used in the output stages, the A.F. signal voltages will have to be doubled and, as the output of the detector cannot be increased without severe distortion, it is necessary to add an additional A.F. stage so as not to overload the detector.

Calculation of Gain

Having determined the minimum R.F. voltages which must be supplied to the grid of the detector to deliver the maximum power output, we are in a position to determine the total gain which must be obtained from the I.F. amplifier.

Modern radio receivers of the super-heterodyne type have an input sensitivity of less than 5 microvolts per meter and, with the standard height of the antenna set at 4 meters, we find that the absolute sensitivity will be about 20 microvolts (a microvolt being one-millionth of a volt). Thus, if we desire a receiver (as shown in Fig. 1) that will deliver about 4 volts of R.F. signal to the detector from an input signal of 20 microvolts, the total voltage gain of the amplifier will be

As it will be impossible to obtain a gain of 133.3 in a single intermediate stage, it will be necessary to use two stages working at a gain of about 65, or three working at 44 per stage.

In the example cited above, the amplification due to the modulating tube is ignored,

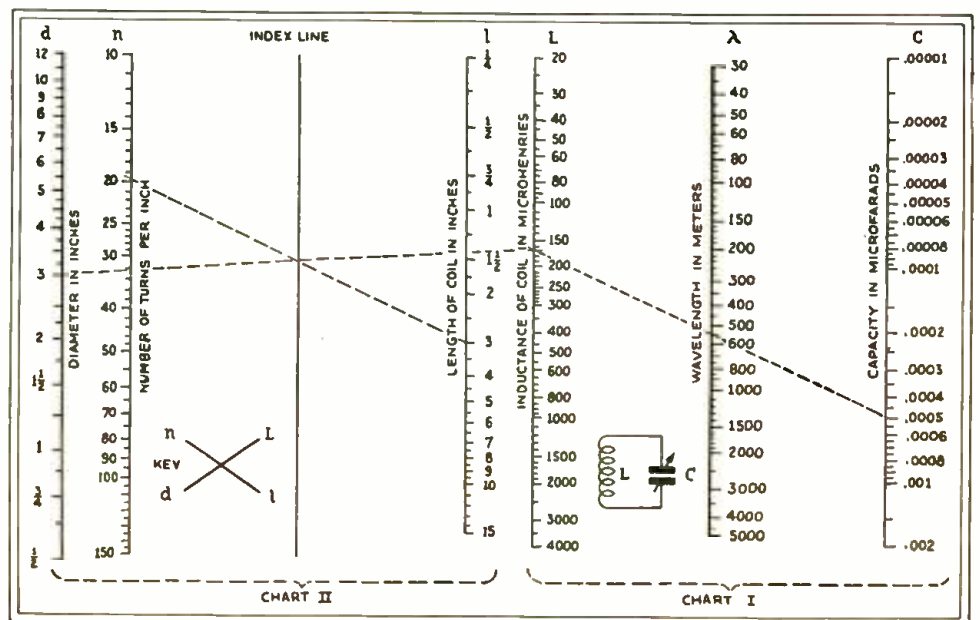

Fig. 9

An automatic coil-condenser calculator. Knowing the value of either a coil or a tuning condenser, the other may be determined, for any wavelength by reference to the chart.

An R.F. Tuner Chassis

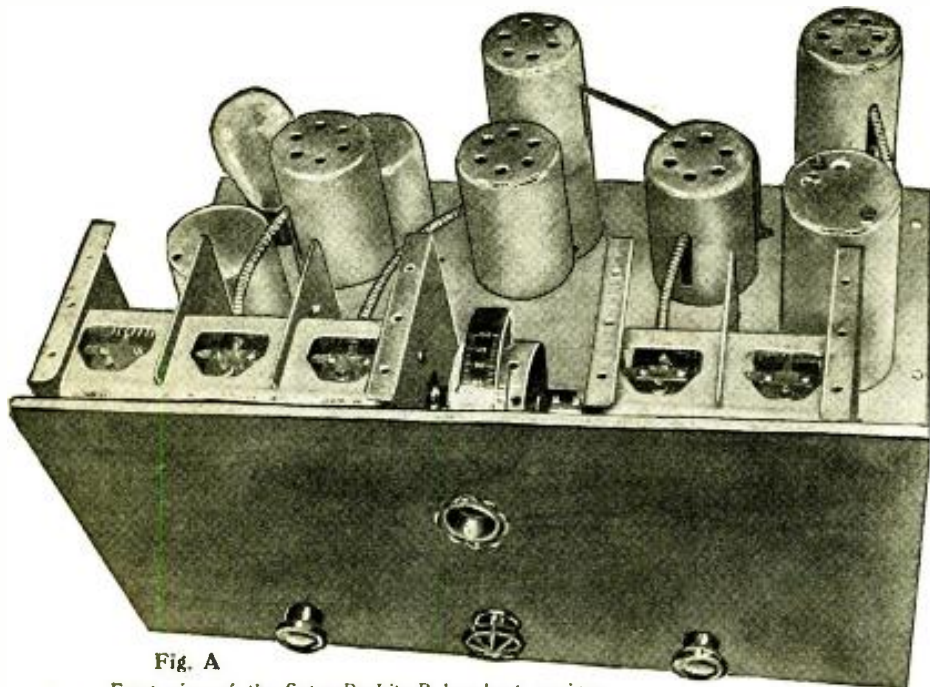

Fig. A

Front view of the Super-Da-Lite-R broadcast receiver.

DURING the past years, RADIO-CRAFT has contained advance information on a series of receivers designed by E. Bunting Moore, commencing with "Everyman 4," and progressing through the "Moore-Daniels DX-5," "Moore Super DX-R," and, last year, the "Da-Lite-R." All of these sets were arranged in kit form for the home builder. This year, Mr. Moore has brought forth a receiver which he calls the "Super-Da-Lite-R." This receiver is of particular interest because, utilizing nothing but standard circuits, and without any "tricks" or "freaks," it contains in one receiver practically every advance and refinement known today to the art of broadcast-receiver design. Multiple band-pass tuning, distortionless volume-control, automatic volume-leveler and fading compensator, diode detection, dynatron oscillator, tuning meter (if desired), single tuning-control, and antenna compensation—all are incorporated in this very simple circuit.

The circuit is shown in Fig. 1, and the layout can easily be seen from Figs. A and B.

Discussion of Circuit

The antenna is coupled to the receiver through an adjustable condenser C4 which may be adjusted from the panel to the proper value for any antenna, whether long or short. An R.F. choke L6 is connected directly between the antenna and ground binding-posts to permit any static charges which may accumulate on the antenna to leak off, and to partially resonate the antenna circuit when a short antenna is used.

The first two tuned-circuits in the receiver constitute a band-pass filter having an effective width of about 12 kc. at 500-ke. setting and 15 kc. at 1500-ke. setting. This

By A. S. WARING

adjustment compensates for the tendency of the succeeding circuits to sharpen up somewhat more at the high-frequency settings than at the low and results in an effective 8-ke. band-pass effect through the entire high-frequency tuning system.

The two R.F. tubes are coupled to each other and to the first-detector tube by a

oscillator circuits, is also the first detector. The oscillator is adjusted to tune 175 kc. higher than the R.F. circuits by using a series-parallel padding arrangement resulting in a minimum to maximum ratio of 5.33 to 1 on the condenser, and an inductance which is 80.4% of the value of the coils in the R.F. stages.

The output of the first-detector tube is introduced into a two-stage I.F. amplifier

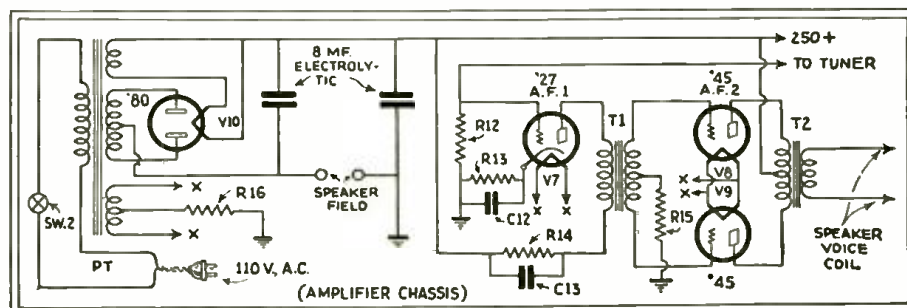

Fig. 2

Schematic circuit of the power unit suitable for use with the Super-Da-Lite-R.

rather unique circuit. A tuned circuit is introduced into each plate circuit, resonated at 600 kc., and a small capacity of the order of 10 muf. is used to couple the plates directly to the grids of the succeeding tubes. The capacity coupling is progressively more efficient as the frequency approaches the 1500-ke. end of the band while the reactance in the plate circuits increases the amplification in the tubes themselves at the low-frequency end, the combination resulting in a measured amplification per stage of between 38 and 41 over the entire band.

A dynatron oscillator, known in engineering circles since 1924 as the most stable of

using band-pass circuits throughout, and tuned permanently at 175 kc. This amplifier has an over-all amplification of 48,000. Both grid circuits are provided with overload compensation circuits to prevent the tubes from drawing grid current and blocking on very powerful local signals.

A diode detector, formed by a '27 tube with grid and plate tied together, is used for the second detector. Since this type of detector operates on the same principle as a crystal, viz., pure rectification without any natural amplification rather than the usual tube-detection as a distorting amplifier, the inherent distortion of the latter is com-

WE AIM TO PLEASE!

Editor, RADIO-CRAFT:

Will you kindly publish an article, in the near future, on the construction of a modern radio tuner.

I have made several unsuccessful attempts to modernize the R.F. stages of an old "'26 and '27" set by using type '24 and '35 tubes. The amplifier parts and power packs are still O.K.; there is enough "A" and "B" voltage to accommodate two or three more 2.5-V. tubes.

A unit like this should be of great value to Service Men who modernize old sets.

R. PECK
Philadelphia, Pa.

(This letter will serve to introduce the R.F. tuner described by Mr. Anthony Swale Waring. Further information on coil design appears in the articles, "R.F. Coil Design," by C. W. Palmer; also, "The Design of R.F. Transformers," by Sylvan Harris.—*Technical Editor.*)

pletely avoided, and the quality of reproduction is reminiscent of the beautiful tone of a crystal set, which we have often longed for in an all-tube receiver.

A filter is placed in the output of the detection circuit. Radio frequency is blocked by the R.F. choke L9 and bypassed to ground through condenser C14. The audio component of the rectified current completes its circuit through R11 which causes a drop across it which is applied to the grid of V7.

The D.C. component of the current passing through R11 develops a voltage (IR) drop across R11 which is directly proportional to the signal, and ranges in value from about 1 volt on a very weak signal to 20 volts at the strength which will just operate the power tubes without overload.

The switch of R11 is connected through suitable filters to the grids of the R.F. amplifying tubes, so that with SW.1 up, the entire voltage developed across R11 is added to the normal negative bias on the grids of these tubes. As a result, the amplification is ordinarily reduced by a value directly proportional to the incoming signal, and the voltage delivered to the audio will tend to remain substantially constant regardless of whether a loud or weak station is tuned in. The entire dial may be swept without any blasting on locals or loss of DX stations without ever touching the manual volume-control.

The Power Amplifier

The power amplifier is a standard circuit using '45 tubes in push-pull. The output of the receiver is ample to excite these tubes to their maximum even on a very weak distant signal, and would badly overload pentodes were it not for their 30% third-harmonic distortion characteristic, which latter is alone sufficient to bar them from any receiver out of which real quality is expected.

This receiver, operating during the past three months in the heart of New York's downtown skyscraper district, has consistently brought in: WTIC (Hartford); WIP, WFI, WCAU (Philadelphia); WGY (Schenectady); WPG (Atlantic City); and WTAM (Cleveland). These stations have been received during daylight hours and, during evening demonstrations, the receiver has never failed to produce Mexican and Pacific Coast stations by 9:00 P.M., E.S.T.

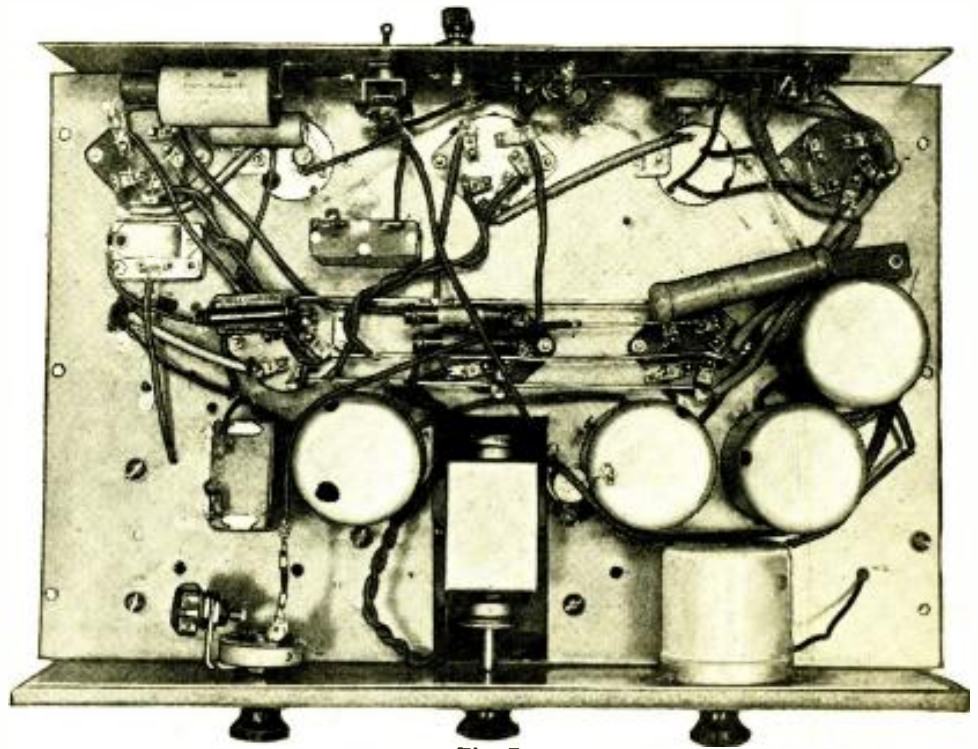

Fig. B

Under-chassis view of the sensitive broadcast tuner.

Stations on both adjacent channels to each of the powerful locals are readily received. In many localities, the use of automatic volume-controls is not necessary. For such cases, the switch SW.1 is used. When it is thrown down there is no automatic volume-control, and when it is thrown up, the A.V.C. is connected. To vary the amount of automatic control secured, R11 may be made variable as a potentiometer, the arm of the switch being connected to the arm of the potentiometer.

Parts List

- One set Moore "Super-Da-Lite-R" coils, L1, L2;
- One set Moore "Super-Da-Lite-R" tuning coils, L3, L4;
- One set Moore "Super-Da-Lite-R" oscillator coils;
- One set Moore "Super-Da-Lite-R" I.F. transformers, L5, L7, L8, L9;
- One Moore tuned antenna impedance, L6, C4;

- One Moore enameled steel chassis;
- One three-gang .000365-mf. clockwise tuning condenser, C1;
- One two-gang .000365-mf. counterclockwise tuning condenser, C2;
- One Hammarlund padding condenser, C3;
- Two 1-mf. condensers, C5, C13;
- Two .5-mf. condensers, C6, C7;
- Three .02-mf. condensers, C8, C9, C10;
- One .002-mf. condenser, C11;
- One bypass condenser, 4 mf., C12;
- One 3,000-ohm volume control R1 with line switch SW.2;
- One 225-ohm resistor, R2;
- One 12,500-ohm resistor, R3 (25 watts);
- One 25,000-ohm resistor, R4 (25 watts);
- Two 100,000-ohm carbon resistors, R5, R6;
- One 7,500-ohm carbon resistor, R7;
- Two 250,000-ohm carbon resistors, R8, R9;
- Two 50,000-ohm carbon resistors, R10, R15;
- Two 25,000-ohm carbon resistors, R11, R14;
- One 500,000-ohm carbon resistor, R12;
- One 2,000-ohm resistor, R13;
- One 750-ohm resistor, R16.

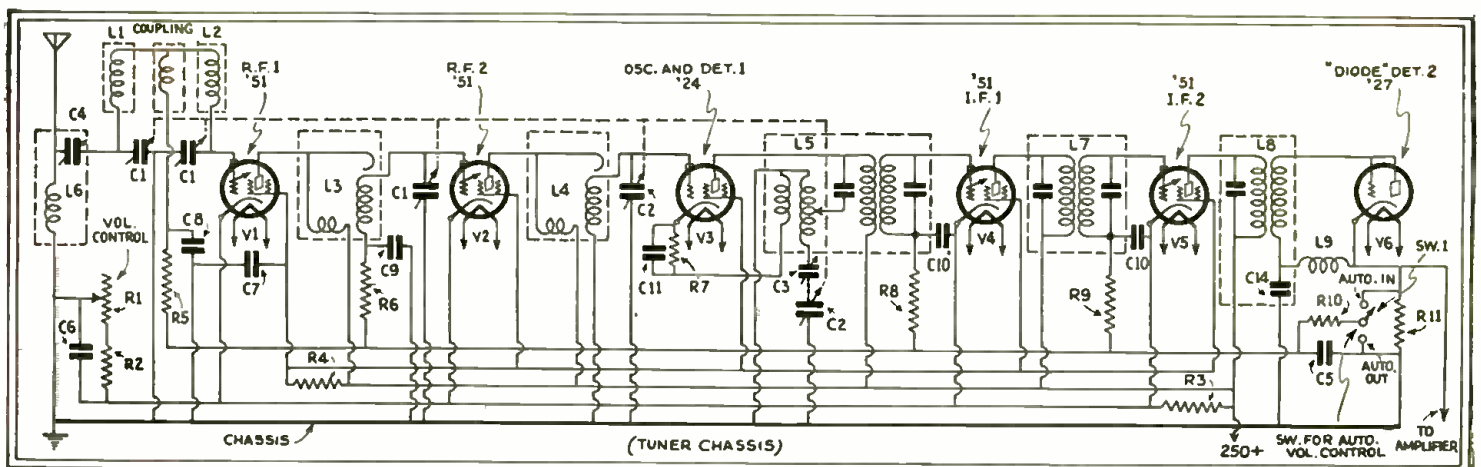

Fig. 1

Complete circuit diagram of the tuner. This tuner employs automatic volume-control, band-pass tuning and variable-mu tubes.

AN IMPROVED *Band Selector*

A description of a novel band selector used for obtaining a "flat-topped" response curve. It uses but two tuning condensers and is the equivalent of four.

WHEN a receiver's selectivity (that is, the degree of separation of a radio signal of one carrier frequency from undesired waves of different carrier frequencies) is accomplished by the usual method of employing a tuned circuit, or several circuits, the frequency-response characteristic of the receiver is rather "peaked" (Fig. 1A) since there is only one frequency at which the capacitive and inductive reactances of the circuit are balanced. At any other frequency there will be an unbalanced reactance, which cuts down the response to such frequency. Thus, in receiving a modulated wave, such a system will receive one frequency of the band effectively and the other frequencies of the band less effectively or not at all, with resulting signal distortion.

By H. F. DALPAYRAT

tangular form as the number of the individual units of the filter increases.

Another means, which has been suggested for obtaining a broad-band reception characteristic in a receiver, consists in the use of a number of variable condensers placed in different tuned circuits (such as the tuned circuits coupling successive amplifying stages) and detuning these circuits in respect to each other in such a manner that, by the combination of their individual peaked resonance characteristics, the band-pass characteristic in the output circuit of the receiver is obtained. (Fig. 1B).

The disadvantage of the latter method lies in the necessity of a great number of tuning elements in each stage, or a combination of staggered tuning elements in several stages, whereby the construction of the set is unnecessarily complicated; or else the amplification in each of the stages of tuning does not reach its maximum amount, since the maximum amplification will occur only when exact tuning is obtained in each stage.

Furthermore, it has been found, when using such a filter circuit in the antenna, or between the antenna and the receiver, that it is necessary to use more than two units for such filter, in order to obtain a practically square-top curve. The conditions of broadcast reception today require a frequency-response characteristic in the receiver which will cut off sharply at the limiting (high-modulation) frequencies of a ten-kilocycle broadcast channel.

especially designed for broadcast reception, which will have at least a double effectiveness on the sharpness of the frequency cut-offs at the limits of the broadcast channel to which the receiver is tuned, and with a small number of filter units (preferably two). To obtain this effect, the energy applied to the input of the filter, after passing the same, is wholly or partly fed back, preferably after amplification, to pass the filter a second time; and is, only then, applied to the receiver itself. By thus utilizing the filter twice, so to speak, the effect of a filter having double the number of circuit units is obtained and, accordingly, an improved response-characteristic, as to the sharpness of the cut-off frequencies.

A further object, achieved by my invention, is that of stable regeneration sufficient to increase the signal to a considerable extent, over the full wavelength range of pass filter action suitable for the proper tuning; at the same time retaining the band-reception of signals.

The fundamental circuit of the regenerative filter is shown in Fig. 2; and a simplified version in Fig. 3. The tube V1, it will be seen, is connected backwards; that is, the aerial coupler secondary is across the plate. The band-pass filter, designed to extend the frequency-response range, consists of the two tuned circuits L3-C1 and L4-C2 (Fig. 2). These are coupled by the small series-condenser C3, while C1 and C2 are operated by the same dial knob. This filter is simple and cheap in design; and it gives increased sharpness of cut-off at the edge of the band.

The method of its operation is this: the signal input from the antenna is trans-
(Continued on page 627)

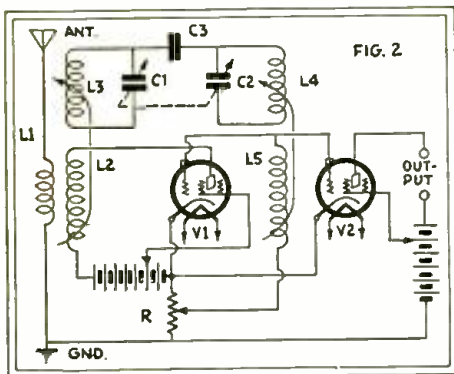

Fig. 2

Diagram illustrating the manner in which the band-pass circuit is connected.

Band-Pass Filters

In order to overcome this disadvantage, it has been proposed, in the past, to construct a receiving circuit in such a manner that it is, so to speak, transparent for a definite band of frequencies, instead of a single frequency; in other words, its frequency-response characteristic assumes a "square-top" shape instead of the markedly peaked shape corresponding to a single tuned circuit (See Fig. 1B). Such circuits are well known and commonly called band-pass filters; they consist essentially of a definite number of individual units or circuits, thus constituting a chain of reactances connected alternately in parallel and in series. It is well known that the sharpness of the frequency-response characteristic of such a filter increases with the number of filter units; or in other words, the cut-off frequencies at both ends of the band become more marked and the curve assumes a shape closer to the ideal rec-

Feed-back in the Filter

The writer has applied for a patent on a new, improved band-pass filter system,

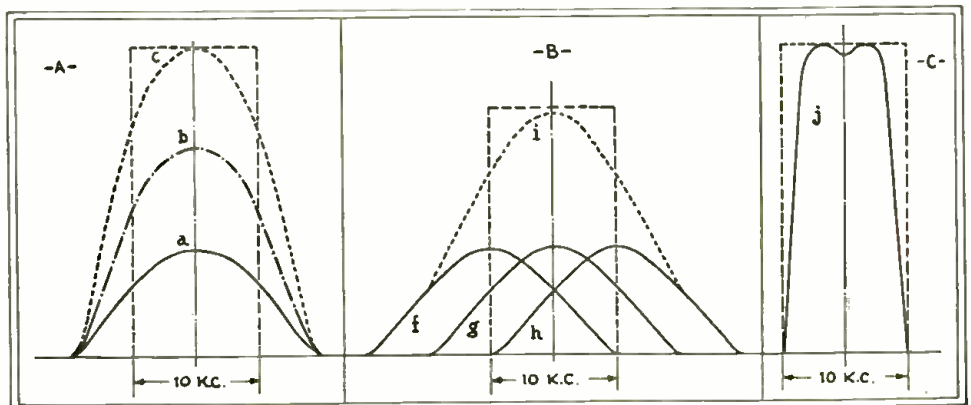

Fig. 1

At A left, the response curves at the output of three tuned circuits, a, b, and c. At B, the over-all response with the three tuning condensers detuned, and at C, the response of the new band-pass tuner.



EVER since the inception of human existence, there has been recognized a need for association in one form or another. This is manifested in our present-day civilization by the existence of armies, navies, trade unions, clubs, fraternities, etc. Every profession has its association and, because of them, a consolidation of individual facts is possible. Taken by itself, a fact usually does not have much meaning, but when verified and added to other related facts, a much more comprehensive knowledge of the subject may be obtained than would otherwise be possible.

The radio profession, as well as others of a technical nature, may be roughly subdivided into three categories; the scientific, the engineering, and the service fields. The first two are beyond the scope of this discussion, but it is the third that we are especially interested in.



Official stickers of the O.R.S.M.A.

necessity of such an association, but also by that class of "quacks" who, by their consistent fraudulent operations, make the demand for a recognized organization of trained men all the more imperative.

The O.R.S.M.A.

With the above facts in mind, an organization called the **OFFICIAL RADIO SERVICE MEN'S ASSOCIATION** was formed in the fall of 1930 and incorporated under the laws of the State of New York in November of the same year. During the period intervening between that time and the present, 15,000 men have responded to its call. It is the hope of the organization that 100,000 men will eventually be enrolled. It should be emphasized that the O.R.S.M.A. is strictly a *non-profit* association, it being maintained at considerable expense by a group of influential men who comprehend the advantages to be secured by such an organization. There is no "initiation" or entrance fee; a Service Man

*Executive Secretary, THE OFFICIAL RADIO SERVICE MEN'S ASSOCIATION.

By **FRED BOEHM***



The O.R.S.M.A. seal.

Radio Service Men have attempted to unite many times. They have failed in the past because of lack of sufficient support, lack of finances, or lack of proper organization methods. The need for an association of qualified Service Men is apparent. This need is being pushed into the foreground not only by men who have the foresight to recognize the ne-

Member's Signature

Date 1/28/32

OFFICIAL RADIO SERVICE MEN'S ASSOCIATION

This certifies that

Harold Tuttle

who has satisfactorily proved his technical qualifications as a Radio Service Man, by passing the examination of this Association, has been accepted as a member of the

OFFICIAL RADIO SERVICE MEN'S ASSOCIATION

and that we commend him to the Radio Trade, and to the owners of radio receiving sets, as a duly qualified Service Man.



Fred Boehm
Secretary, Official Radio Service Men's Assoc.

No 6843

Membership card issued to members of the Association.

who wishes to join is not financially obligated in any manner, shape or form. It is maintained for the benefit of the service field as a whole and not as a means of gaining a livelihood.

How to Become a Member

When a Service Man desires to become a member (one of the requirements is that he must be a

Service Man) he applies to the offices of the Association. His name is immediately placed on file and a printed examination is forwarded to him. The applicant is on his honor to take the examination himself. It has been the experience of the Association that when a man is placed on his honor, the examination will be executed properly. If an applicant fails, he may take the examination again after three months. The papers are prepared and are graded with the cooperation of a group of nationally-known organizations which are:

Service Record-card which also may be secured.

RADIO SERVICE SHOP
 2423 Penn. Ave., N.W.,
 Washington, D. C.
 West 2289

Name _____

Address _____

Phone _____ Date _____ 193__

Make _____ Model _____

Type _____ Power _____

Information _____

Tubes		
Parts		
Labor	Hours	Per Hour
Service		
Terms		Total
Serviced by		

This set now operates to my entire satisfaction, and above charges are OK.

Signature of customer _____

For your protection, sign after "TOTAL" on above slip has been completely filled in.

The Crosley Radio Corporation; Grigsby-Grumow Company; Stromberg-Carlson Telephone Mfg. Co.; Colin B. Kennedy Corp.; RCA-Victor Company, Inc.; Stewart-Warner Corp.; RCA Institutes, Inc.; East-Bay Radio Institute; Radio Training Association of America; School of Engineering of Milwaukee; Radio College of Canada; Radio Division, Coyne Electrical School.

After the applicant has passed the examination, he receives a card which, as may be seen, bears the photograph of the member and the seal of the Association in order to avoid forgery.

Stationery

There are many members who correspond a great deal and, (Continued on page 621)

Operating Notes

The Analysis of Radio Receiver Symptoms

By D. C. McCALL

ANOTHER Monday and it's starting off as usual with lots of service orders. I used to wonder why Monday was always a busy day with the radiotrician but I think it is easily explained by the fact that people have more time at home on Sunday and consequently notice the shortcomings of their radio.

this circuit, there is a detector-plate resistor that apparently has no coupling condenser to the parallel grids of the power tubes, but there is where the trick comes in. The coupling condenser is concealed under the fiber mounting-panel and the lead from this condenser is brought through this fiber and the end of the lead connected and hidden by a drop of solder on the plate-resistor soldering lug. Enough heat to make the solder at this junction run will remedy a bad connection and eliminate the complaint of "cutting off." In fact, I always heat this joint when working on the Brunswick 15 or 22 chassis.

The big, black, carbon resistor (bleeder) is supposed to be 20,000 ohms but tests only 3,000 ohms.

Replacement of this resistor with a high-wattage, wire-wound resistor of correct value secures a miraculous return to "peppy" performance in this set, and the customer is delighted with the small repair bill, as he has learned to dread power-pack repairs as expensive.

Next order says, "Owner refuses to pay for radio until fixed, complains of peculiar vibration or distortion on voice. You are fourth Service Man to be sent. FIX IT. Brunswick S31." Now that sounds bad. I find the owner at home and "sore as a boil" on the subject. He says, "You're the fourth man out here—hope you surprise me by really doing something."

I ask this man questions until he seems annoyed so I say, "Mr. X, I hope you will permit me to ask questions because I am earnestly trying to get to the bottom of this trouble and remedy it. And you know," I added, "my Company wants to please you and, besides, it will be to my credit to fix it. So please don't take the attitude that we are too dumb to realize that your satisfaction is of paramount importance."

He looks at me peculiarly and says, "I believe you *do* want to fix the darn thing, but all the other guys sent out here seem to think I'm unreasonable and a bit nutty." I laugh heartily and he manages to put on a weak smile, the first sign of good humor he has shown. Then and only then do I turn on the set.

I notice a slight rattle of the speaker cone but say nothing as I want this man to tell me what he hears. But he seems not to notice this. Then I switch to "distance" on



"We make it come back by wiggling the big tubes in their sockets."

Well, let's see if the tool bag and collection of gadgets are all here. Yes, everything is shipshape and the much-abused (but also much-used) test set is O.K. and ready to help me "Read 'em and Weep."

Brunswick "15"

Here's the first order: "Service Brunswick 15—cuts off." An early-morning "massage" on the owner's doorbell and the maid lets me in with the remark, "The radio is playing alright now but it cuts off sometimes." That information isn't very helpful, for a great many things could cause that trouble, but I begin a quiz of the maid.

You know, servicing radios is a bit of "Sherlock Holmes" stuff in analysis and deduction, and a chance remark of the set operator may be a clue that leads directly to the trouble which otherwise might take lots of valuable time to locate. This is a typical case for, in answer to one of my questions, the maid volunteers the information "that we make it come back on by wiggling the big tubes in their sockets."

"Ah!" I say, "That's simple." For previous experience has taught me a trick about that complaint. Plugging in my soldering iron, I remove the chassis. The detector is resistance coupled to a pair of parallel '45's. In

Radiola "60"

And the next order reads, "RCA 60—lost its pep." As I hustle across the lawn in the early morning sunshine, I shoot an eager eye over the antenna installation. It is a clean-cut job and doesn't give any signs of trouble there. The owner is at home and points



"The customer is delighted with the small repair bill."

out that the set is dead until the volume is advanced all the way, and then it plays weakly.

A check of the tubes on an A.C. checker shows them to be normal. Plugging in the analyzer, I find low plate-voltage all over and the "M.A. test" in the plate circuit of each tube causes the needle to barely wiggle. A certain sign of something wrong in the voltage-distribution system. I suggest taking the set to the shop for careful analysis.

Later, at the shop, after failing to find a short in the filter or bypass condensers, I measure all resistors and check these readings with the values given in the schematic.



"That's it, hear it?" cried the customer.



"Wonder when truth in advertising will appear in the radio world?"

the L-D switch (although we are tuned to a local station) and reduce the volume control. Instantly there is real distortion.

"That's it," the customer says excitedly, "hear it?" Then I explain that the set overloads and distorts when the signal input is too great, as it is with the switch on "distance" and the set tuned to a local. He instantly takes the attitude that I have proved him in the wrong and he emphatically denies using the switch incorrectly. Furthermore he gets sore again.

So I see that I have to "kid him along" some more. He is just dying to see someone plunge into the insides of that set so I decide to satisfy him at any cost. Suddenly, I say, "By Jove! I hear it now. That's the voice coil of the speaker rubbing the field magnet." And I proceed to rip loose wires, loosen bolts, screws, etc. He watches with fascinated interest as I show him how I center the voice-coil spider.

After I reassemble it, he says it sounds fine and is genuinely pleased. But I know (and I expect he realizes it, too) that when he turns his switch on "distance" and tunes in a local, he will hear his trouble again. But he hasn't complained again and he won't complain again. He'll be ashamed to. The boss complimented me on fixing this instrument—but I think it was a case of "fixing" the customer.

The next few calls are new sets that have failed because of bad tubes. I fix these in short order, but am careful to explain to the new owner in each instance that one or more tubes out of a new set are likely to prove defective in a few days, and that this does not mean that the radio is "burning out tubes too fast."

Crosley Showbox

And now here's a "pain in the neck." "Crosley Showbox you serviced yesterday still cuts off—complaint on your work—no charge." How I hate to see an order like that! Makes me want to crawl in a small hole and pull it in after me. The Boss always thinks the worst (carelessness on the Service Man's part) on such a call-back, and it mortifies me every time, although I know it's impossible to have a perfect batting average on radio service.

The day before, I had replaced an erratic

'27 tube in this set and thought I had cured the complaint of cutting off. I take this set to the shop and flounder around some time on the wrong track. A thorough check shows no defective resistors, condensers, tubes, or bad connections until suddenly I discover a bad speaker-cable where the field-supply wires are shorted onto the output of the set (Dynacone speaker). I replace this cable and the set plays beautifully in the shop for hours.

Next day, before taking it back to the owner, I turn it on for final test—and it cuts off! While debating whether to smash it with a sledge hammer or throw it out the window, a bright idea comes to me. Examination shows that the tension spring on the rotor shaft of the tuning condenser is adjusted by a collar and set screw on the back of the shaft. Shaking the rotor shaft causes the set to cut off. I loosen this collar, clean the contact points, and then force the collar back against the tension spring and tighten the set screw. Then a drop of Nujol on the contact bearing, and the Crosley stays fixed this time.

And now an antenna to put up and then a few more calls on bad tubes, together with the never-ending explanation to new customers that they will get static even if the set manufacturers' advertisements promise them "quiet reception on far-away, weak stations just like your locals." Wonder when truth in advertising will appear in the radio world? But as one Service Man said, "It's up to the Service Man to sell 'em on the idea of getting a little static along with the bedtime story."

Ho-Hum! It's eight bells and the day's or, rather, the night's work is done. Gee! I'm as exhausted as a race horse. As I crank up the "Model T" and head for home, I wonder if the average person realizes the hard manual labor and the nervous tension of trying to please everyone, along with the mental exertion required, that fall to the lot of the radio Service Men?

Oh, well! That just makes home seem the better place to be. Here I am and, Oh Boy, I wonder if that delicious odor of ham and coffee is coming from my kitchen? Well, here's to hoping!

PHILCOS, BOSCHS AND STROMBERG-CARLSONS

By BERTRAM M. FREED

Philco Models

Lack of all "B" voltages in Philco Models 111 and 112 receivers may be due to various common causes and defects, which are easily found (if the Service Man knows where to look for them). One reason for this condition that is not so readily ascertained is an open section, or sections, of the 70-ohm center-tapped resistor connected in the negative return circuit of the high-voltage winding. This wire-wound resistor is located adjacent to the '80 socket, and is indicated in Fig. 1.

The Philco 90 series is frequently serviced because of hum. The close proximity of the audio stages to the rectifier results in a certain amount of hum caused by coupling. The manufacturer has provided for this, by furnishing a shield plate which must be inserted in its clips between the pentode tube and the rectifier. For minimum hum, care should be exercised in selecting the pentode and first A.F. '27 to be used in the receiver. In most cases, slow-heating '27 tubes have been found to develop the least hum.

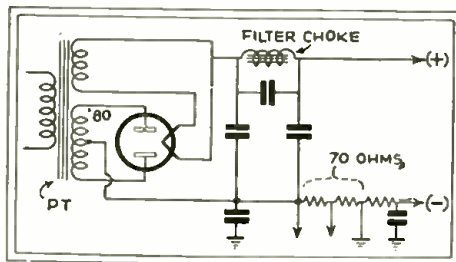

Fig. 1

Detail of the power unit of the Philco models 111 and 112 receivers.

Bosch Models "48," "16," "17" and "J"

Often the complaint of weak reception will be had on the Bosch "48," "16," "17," and "J" models. The usual service procedure of many Service Men in isolating the

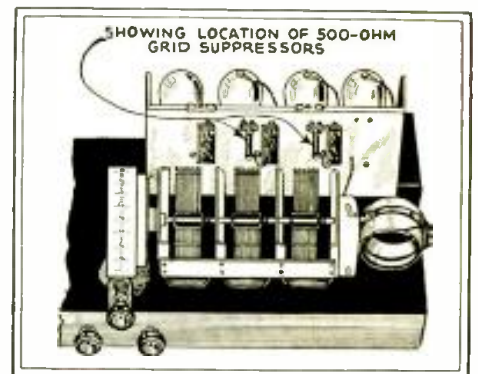

Fig. 2

Chassis layout of the Bosch 48 and 49 series showing the location of the grid suppressors.

cause of the complaint stands them in good stead in this particular case, because using a set analyzer will not disclose the trouble unless every test is made on that particular stage and every deviation from the normal heeded.

Many men use the aerial wire and start with the 1st R.F. to determine the stage that is inoperative, by touching the aerial wire to each screen-grid control-grid cap. With the set analyzer, an increased plate-current reading will be obtained as well as no control-grid voltage, a test which many men neglect. This is caused by an open 500-ohm carbon resistor in the control-grid circuit of either the 2nd or 3rd R.F. stage, and will cause a marked decrease in receiver sensitivity and selectivity. (Fig. 2.)

Stromberg-Carlson Models "19" and "20"

A stubborn case of hum in the new Stromberg-Carlson models "19" and "20" receivers recently caused some bewilderment on the part of several Service Men. Every circuit would check in proper manner. Condensers were checked for open circuit by bridging with others and by discharge test.

(Continued on page 633)

The Service Man's Forum

Where His Findings May Benefit Other Radio Technicians

RADIO-CRAFT

Editor, RADIO-CRAFT:

I wish to call your attention to an error in the circuit diagram of the DayRad "Type L" as published in the August, 1931 issue of "RADIO-CRAFT's Information Bureau." The circuit of V1 resolves into the following:

The circuit doesn't look practical with the plate at a negative potential with respect to the cathode.

In the September, 1931 issue in C. W. Palmer's article, "The Design of Power Transformers," shouldn't the "Current Draw (Milliamps.*)" in Table III be multiplied by 10?

I realize the tremendous task of putting out a 100% periodical so this letter is in nowise a criticism. If that DayRad diagram is incorrect, would you mind printing a corrected one?

A. STRANTMAN,

Maple Ave., Glenbrook, Conn.

(The comments by Mr. Strantman show that he takes a keen interest in the columns of RADIO-CRAFT.)

The circuit of the DayRad "Type L" tester is correct. Refer also to the February, 1932 issue of RADIO-CRAFT, page 475, and the March, 1932 number, page 550.

You take the second trick; Table III should be multiplied by 10.—*Technical Editor.*)

HE STARTED FROM THE BOTTOM

Editor, RADIO-CRAFT:

I am 23 years old and since I built my first "teaser," a lot of water has flown down this old Muddy of ours. Being rather practical minded, I almost immediately capitalized my yen for radio.

This community boasts of but 8,000 people and only two remain of the many that called themselves radio "experts" from time to time. Needless to say, I am one of them and the other is a newcomer and much remains to be seen. For that matter, let me say right here, never underrate a competitor; instead, make yourself unquestionably better and the public will be quick to find out.

To me, radio is something more than to just make a living with, but I do manage to live; and decently. I drive a good car and contribute to Uncle Sam annually about March 15.

This business of being a good Service Man is something to capitalize. Be a little more practical. Every one of your customers, sometime, will be in the market for a new radio or accessories, and you're the fellow that can sell him. I sell a lot of radio sets—if in doubt, get in touch with my distributor. First of all, don't hide your light; you must constantly remind your public of yourself and of what you can do for them.

E. J. KNOLL,

Nebraska City, Nebr.

A WARRANTY CARD

Editor, RADIO-CRAFT:

There have been appearing in RADIO-CRAFT from time to time some very interesting ideas on the business end of radio servicing, some of which the writer has put to good use in conducting his own service business.

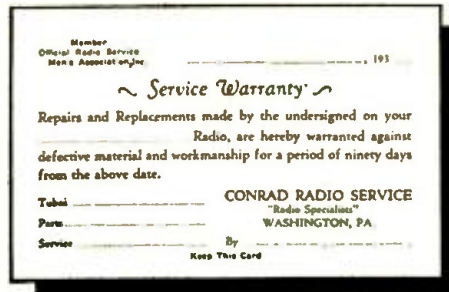

Fig. 1

The warranty card of Mr. Conrad.

The following method has been used by us with very good results:

A personal "thank you" letter and warranty card (a sample of the latter is illustrated in Fig. 1) are sent, after the completion of every job, to both old and new customers. Any Service Man can readily appreciate the good-will and free publicity the use of such a letter and card will bring him.

Hope you can pass this along to your many readers, of which the writer is one.

P. C. CONRAD,

67 Wilson Ave., Washington, Pa.

"RADIO SERVICE"

Editor, RADIO-CRAFT:

Just a few lines from an old timer, one of your "MODERN ELECTRICS" friends. What kind of a game has this thing called "Radio Service" become?

I have been working with electricity, wireless telegraphy, and so-called radio, ever since I was a schoolboy, or, to be exact, about 25 years. In this period, I have spent several hundred dollars for books, tools, test apparatus, and experimental work. During my career in the work, I have been experimenter, student, set-builder, factory service engineer, and independent radio service operator. Also, I have sold many sets and acted as Service Man for regular authorized dealers.

As you may be aware, it is hard enough for a good Service Man in the city to make a decent living; it is next to impossible for one in a small town to even exist, with the forces, which I shall describe, at work to hinder and make it a regular farce to try to service sets right.

To begin with, the manufacturers make it just as hard as possible to repair their sets, without having their own make of parts which are of a non-descript variety of shapes, sizes, and questionable values. Then, when we Service Men do try to give

the owner some sort of decent assistance with his troubles (and believe me, regardless of these "big guys" say-so, their sets have plenty of imperfections and careless workmanship, to say nothing of often times poor design), the wise (?) manufacturer refuses to give us any information; or sell us parts except at the retail prices, so we cannot make anything out of a job.

His excuse is, "Oh! we have our own dealers who look after that." In some cases, they do have a competent service department, but in most they do not, which means dragging the set out of the owner's home, then sending it to the distributor; in about two weeks or more, it comes back and I have noted that in some cases it plays O.K. and (wonder?) sometimes it is not a mite better than before, regardless of their "baloney" that their service department is the one and only.

Now, all this sums up to this, that myself as well as many other old and experienced Service Men (and by that, of course, I mean men who have specialized in this line of work exclusively) are being forced to give up our chosen and well-liked line of work, to take up anything, no matter how unskilled it may be, in order to at least make a living.

Don't you think it a rotten state of affairs?

GEO. G. MITCHELL, JR.

P. O. Box 55, Hackettstown, N. J.

(MODERN ELECTRICS—1908 to 1913—was the first magazine published by Mr. Hugo Gernsback; its readers have seen nearly the entire gamut of radio development.)

While our correspondent is quite justified in his remarks in many respects, it is equally true that manufacturers are rapidly learning that, after all, the radio Service Man is really their "contact man," and his say-so may have more weight with the average set owner, who has great respect for his technical ability, than the longest sales talk of dealers' salesmen. For this reason, among others, many set manufacturers have spent hundreds of dollars in the preparation of special "helps," in the form of service manuals, etc., as stated in this department in past issues of RADIO-CRAFT.—*Technical Editor.*)

MORE ABOUT A. K.

Editor, RADIO-CRAFT:

I wish to answer the article by Jack Levine in regard to A.K. service manuals.

I agree with Mr. Deunna on his article in the September issue of RADIO-CRAFT.

The Atwater Kent Co. will not supply any but regular dealers with their manual. I have a letter here before me signed by Mr. F. Atlee of the Atwater Kent Co. to that effect.

I also have a letter from the Jersey State Distributors, Inc., 1010 Broad St., Newark, N. J., handling A.K. products which says

(Continued on page 631)

SHORT CUTS in RADIO SERVICE

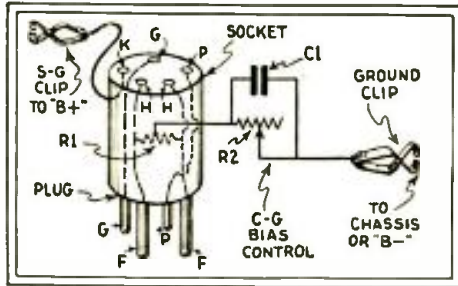

Fig. 1

The pentode adapter described by Mr. Kearns.

(PRIZE AWARD)

A PENTODE DEMONSTRATION ADAPTER

By J. Richard Kearns

MANY owners of sets incorporating a '45 output tube could easily be convinced of the desirability of having their sets changed to '47 pentode operation if they could have a demonstration of the greater sensitivity of this tube and the tonal effects which may be obtained in their own sets.

However, the '47 pentode adapters on the market, designed for plugging into a '45 socket, do not enable the tube to give anything near the results of which it is capable. It is necessary to change the grid bias and also to supply the screen-grid with separate voltage, not merely to connect it in parallel with the plate, as is done by some adapters, and no self-respecting Service Man would be satisfied with this latter sort of installation.

The adapter, shown in Fig. 1, consists of a five-prong socket in a four-prong base; the grid, plate, and filament leads being strapped across from the base to the socket, with a lead from the socket's "K" terminal being connected to a clip which can usually be hooked to the speaker field connection, or other external high-voltage source, for the screen-grid potential. There is also a center-tapped filament resistor R1 included, with a 1,000-ohm variable resistor R2 bypassed by a 1-mf. fixed condenser C1, leading to another clip for the connection to the chassis. The control is then adjusted to give correct grid bias, using a voltmeter.

If the demonstration results in a sale, as it usually does, the installation is then made in the proper way, changing sockets and resistors inside the set, the adapter being used only for demonstration purposes.

Of course the bias resistor in the set may be replaced, or shunted by another, depending on which is most convenient. The output transformer designed for '45 operation, while not considered ideal for use with a pentode, in actual practice works practically as well as a pentode transformer; it is seldom necessary to change transformers.

IMPROVING WESTON "537" ANALYZER

By Joseph C. Yaegeer

LIKE a great many other Service Men, the writer was extremely proud of his Weston "537" Analyzer when it was the analyzer, but now when it is necessary to use a half-dozen adapters to test as many tubes—and this is done on almost every

\$10 FOR PRIZE SERVICE WRINKLE

Previous experience has indicated that many Service Men, during their daily work, have run across some very excellent Wrinkles, which would be of great interest to their fellow Service Men.

As an incentive toward obtaining information of this type, RADIO-CRAFT will pay \$10.00 to the Service Man submitting the best all-around Radio Service Wrinkle each month. All checks are mailed upon publication.

The judges are the editors of RADIO-CRAFT, and their decisions are final. No unused manuscripts can be returned.

Follow these simple rules: Write, or preferably type, on one side of the sheet, giving a clear description of the best Radio Service Wrinkle you know of. Simple sketches in free-hand are satisfactory, as long as they explain the idea. You may send in as many Wrinkles as you please. Everyone is eligible for the prize except employees of RADIO-CRAFT and their families.

The contest closes the 15th of every month, by which time all the Wrinkles must be received for the next month.

Send all contributions to the Editor, Service Wrinkles, c-o RADIO-CRAFT, 98 Park Place, New York City.

extra space taken up and the limited range of tests that can be carried out with adapters.

It was with these thoughts in mind that the writer altered his instrument so that it will test all filament, control-grid, plate, cathode, screen-grid and space-charge-grid voltages as well as plate current. In other words, the present-day tubes such as screen-grid, variable-mu and pentode tubes can be tested without the use of adapters.

As is apparent by reference to Fig. 2, a grid test on screen-grid tubes, a reversing switch for the volt-milliammeter and a volt return switch have been added.

The reversing switch is necessary to secure an up-scale deflection of the meter on "A" voltages, cathode voltages and grid voltages. The "VM Return" switch is used to connect the meter return circuit of the plate and grid circuits to either cathode or "F—". The cathode connection is used on ordinary tubes, and the "F—" is used in testing pentode tubes.

Shopping around for parts that would fit in the available space required considerable time. The grid test for screen-grid tubes is an ordinary Yaxley push-button jack switch of the S.P.D.T. variety. This is placed in line with the other two push-button switches in the lower left-hand corner of the panel, and lengthwise with the bottom edge, Fig. 3A. (A piece of the tri-

(Continued on page 628)

job—it is readily apparent that a great deal of time is consumed changing and selecting the correct adapters, to say nothing of the

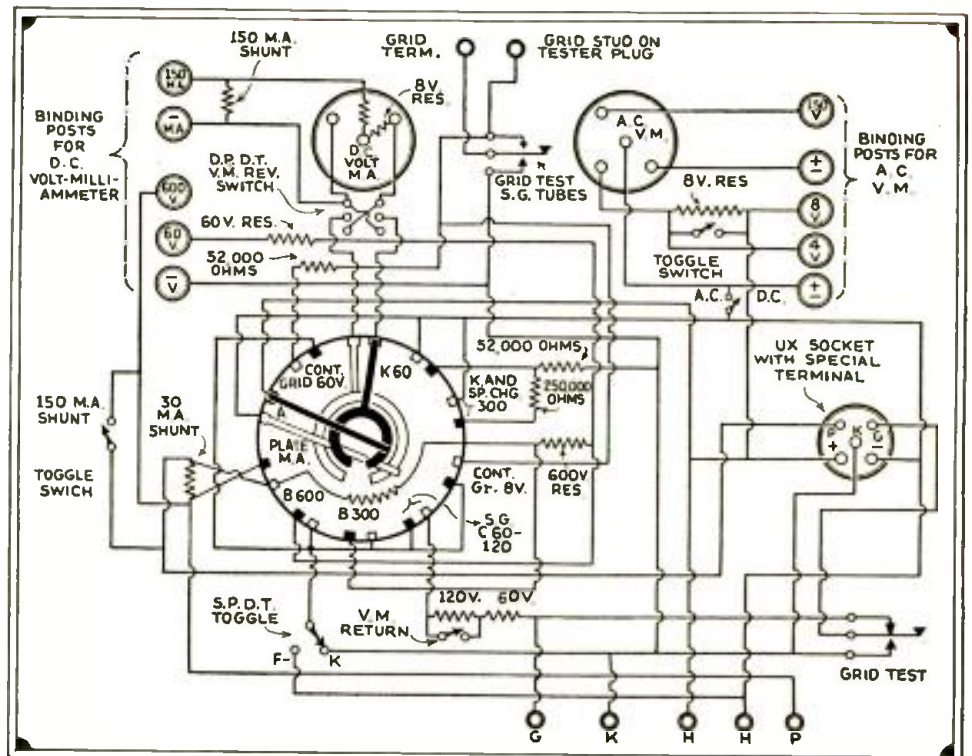

Fig. 2

Schematic diagram of the improved Weston 537 analyzer. It is now able to test practically every type of tube available.

KENNEDY SUPERHETERODYNE SHORT-WAVE CONVERTER

(Model 54 "Globe Trotter")

Short-wave converters and receivers have recently been sold in such large numbers as to require the expert attention of the average Service Man. The Kennedy Model 54 Converter, manufactured by Colin B. Kennedy Corp., South Bend, Ind., for instance, contains numerous points of particular interest to Service Men who previously have only attended to the peculiarities of standard broadcast receivers.

The Model 54 converter operates on the superheterodyne principle, and therefore includes a first-detector—a '24 tube, and an oscillator—a '27. Filament power is obtained from a built-in transformer; the "B" potential is obtained from the standard broadcast receiver, which also furnishes the remaining portions of the superheterodyne circuit—that is, the I.F. amplifier, second-detector, audio amplifier, main power pack; the "C" potentials are derived in the usual manner—as the potential across cathode resistors.

Of course, some broadcast receivers may already incorporate superheterodyne circuits. In such instances, the combination of converter and receiver constitutes a "double superheterodyne," in which the converter's tube arrangement would be referred to as first-detector V1, and first-oscillator V2; and the subsequent tubes in the broadcast receiver then will be designated, respectively, as: first R.F.; second-detector; second-oscillator; I.F. amplifier; third-detector; and audio amplifier.

Parts replacement values: Resistor R1, 10,000 ohms; R2, 400; R3, 25,000; R4, 50,000; R5, 5,000. Condenser C, oscillator tuning; C1, main tuning; C2, I.F. trimmer; C3, C4, 0.1-mf.; C5, C6, 0.25-mf.

The plate current obtained from the standard broadcast receiver for operation of the converter is very slight, and adds no noticeable burden to the power supply of most sets. Two wires, for supplying this power, come out from the side of the short-wave unit, and are to be connected to the long-wave (broadcast band) set. (One is a black lead which is connected to the "ground" binding post on the long-wave set; the other is a red lead, which is connected to the negative

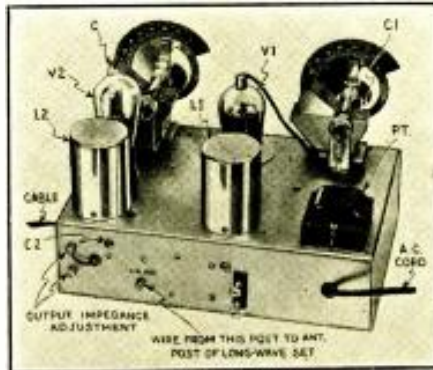

side of the reproducer field coil (dynamic reproducer), to the speaker wire or connection carrying a filtered "B" supply, or (inside the chassis) to the positive end of the voltage-divider resistor.

Any source of "B" voltage from 150 to 250 volts is suitable. It should be obtained from some point in the long-wave receiver speaker or filter system, where it will receive fairly good filtering and be relatively free from hum. A lower voltage, well-filtered, is more to be desired than a higher voltage with a large proportion of A.C. modulation.

Obtaining this plate supply is very simple on many receivers, such as the Kennedy Models 210, 310, 220, 320, 1030, 632, 426, 526, 726, and 826. In these, the "B" supply may be taken from the tip-jack terminating the black speaker wire. In Kennedy Models 42, 50, and 52, it may be obtained at the speaker terminal panel from the side of the field winding which is common with the speaker-transformer primary. Similar points for connection, on other makes of receivers, are usually located without any difficulty. The correct terminal may usually be quickly found by testing from chassis, or ground, to the various speaker terminals. It should rarely be necessary to go inside the

chassis to find a source of "B" power.

If difficulty is had in getting the unit to operate when initially hooked up, and the "B" source is suspected, 90 to 135 volts of "B" batteries may temporarily be tried. The red wire, of course, goes to the plus "B" lead, the black wire to the long-wave receiver ground post as before, and the negative "B" lead to the same ground post.

The antenna and ground wires are entirely disconnected from the long-wave receiver. They are to be connected to the posts marked "antenna" and "ground" of the short-wave unit, and left there permanently.

A wire is also connected from the antenna post of the long-wave set to the binding post on the rear of the short-wave chassis marked "L.W. Ant." This wire should be as short as practical to lessen any chance of broadcast stations being picked up and heard in addition to the short-wave signals.

It will be noted, facing the rear of the chassis, that on the left-hand side a wire has been brought out which may be connected to either one of two small binding posts near the end of the base. The purpose of this is to adjust the output impedance of the unit L2 to that of the antenna input circuit of the receiver with which it is to be used. The Kennedy models previously mentioned have "high impedance" antenna circuits and therefore require this wire to be on the upper binding post. In doubtful cases, this wire may be tried first on one and then on the other, with the unit operating, and permanently left where best results are obtained. These connections are indicated on the diagram and the photographic illustration.

The output of the short-wave unit is tuned. It is set, at the factory, for best operation at about 1,525 kc. Naturally, the long-wave receiver dial must be set at this point for short-wave reception, and left there. The R.F. portion of the long-wave receiver becomes the I.F. tuner and amplifier of the "short-wave superheterodyne." Just past 1,500 kc., a point easily reached on almost all broadcast receivers, has been found most desirable. The volume control on the long-wave receiver also acts as the volume control for short-wave reception; while finding stations, this control is to be turned full on.

In the event the long-wave receiver will not tune past 1,500 kc., or a strong local broadcast station interferes at that point, the output frequency tuning may be altered slightly to avoid the difficulty. An adjusting screw for this tuning may be reached through a hole in the rear of the chassis. It is located near the impedance adjusting wire and binding posts, and is to be adjusted with an insulated screw driver.

Set the main hand-selector switch SW.1 on the position marked "15-25 meters," tune in a station (music or code) at about 50 on the right-hand dial. Then adjust the screw described until the left-hand dial also reads approximately 50 when correctly tuned in. This adjustment then holds for all wave-bands.

For best results, particular care should be taken in the installation of the antenna for short-wave reception. For instance, it should be clear of metal and grounded objects; and its lead-in should not be enclosed in metal conduit. Also, the antenna and ground leads should not be twisted together, or run tightly parallel for any considerable distance.

The right-hand dial of the short-wave unit (looking at the front of the instrument) might be termed the "station-finding dial," operating variable condenser C. It should be adjusted very slowly in order not to pass over the signals of the desired station. At the same time, the left-hand knob, controlling variable condenser C1, should be rotated so that the dials read approximately alike.

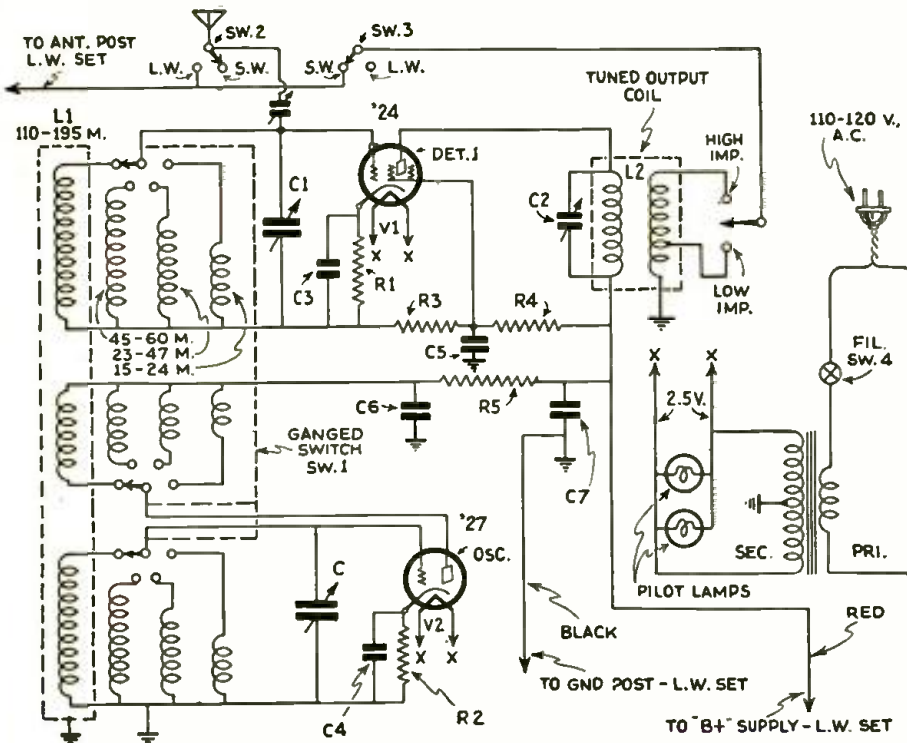

RCA-VICTOR RADIOLA MODEL M-30 AUTOMOTIVE RADIO SET

(Automatic Volume-Control—Push-Push Power Amplification—9 Tubes)

Automotive radio receivers have been undergoing a change, with the primary objective of obtaining in automobiles comparatively the same over-all efficiency which exists in the less mobile "home" installation. A close approach to this degree of perfection is obtained from the Radiola Model M-30 receiver, manufactured by RCA-Victor Co., Camden, N. J.

The values of the components of this receiver model are as follows:

Condensers C1, C2, C3, tuning condensers, 18-325 mmf.; C1A, C2A, C3A, trimmers, 4-50 mmf.; C4, padding condenser, 720 mmf.; C4A, padding trimmer, 10-75 mmf.; C5, trimmers, 15-75 mmf.; C6, trimmers, 140-220 mmf.; C7, 745 mmf.; C8, C10, 0.25-mf.; C9, C11, C12, 0.1-mf.; C13, C14, .0024-mf.; C15, C16, 0.5-mf.; C17, 4 mf.; C18, C19, .018-mf.

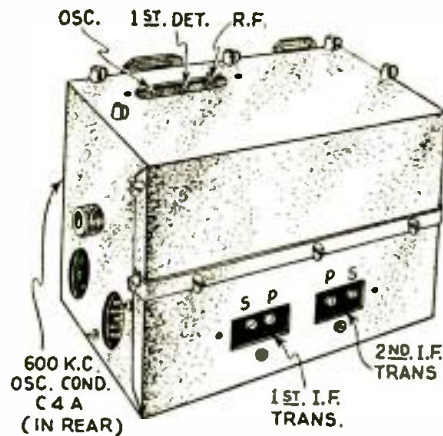

interference should be experienced with the receiver operating at full sensitivity. Approximate operating voltage and current values (obtained on a Weston Model 547 test set), taken with the volume control set at the "minimum" and "maximum" (maximum values shown in parentheses) positions are as follows:

Filament potential, V1 to V6, V9, 6 volts; V7, V8, 4.5 volts. Cathode-to-heater potential, V1, V4, 18 volts; V2, 1 volt; V3, 6 volts; V5, 12 volts; V6, 15 volts; V9, 10 (5) volts. Control-grid-to-cathode (or filament) potential, V1, 0.5-volt; V2, 3 volts; V3, zero; V4, 1 (0.5) volt; V5, 10 volts; V6, 2 volts; V7, V8, 20 volts; V9, 1 (9) volts. Screen-grid-to-cathode potential, V1, V4, 100 (70) volts; V2, 42 volts. Plate-to-cathode (or filament) potential, V1, V4, 136 (135) volts; V2, 150 volts; V3, 45 volts; V5, 110 volts; V6, 165 volts; V7, V8, 155 volts; V9, 15 volts. Plate current, V1, V4, zero (4 ma.); V2, 0.25-ma.; V3, V6, 3.5 ma.; V5, 0.5-ma.; V7, V8, 1.5 ma.; V9, zero. Screen-grid current, V1, V4, zero (1. ma.); V2, 0.1-ma.

Automatic volume-control tube V9 is connected to the cathode circuit of second-detector V5. The change in the bias voltage of V5, due to fluctuation of the signal, is applied to the control-grid of V9, resulting in a drop across plate resistor R7 which constitutes the control-grid bias for the R.F. and I.F. tubes. As the value of the plate current in a tube is a direct result of the voltage applied to the grid, a greater plate current in V9 gives a greater voltage drop across the resistor in its plate circuit and therefore a higher bias on the I.F. and R.F. stages, resulting in less sensitivity, and vice versa; previous A.V.C. systems have operated on different principles. Manual volume-control resistor R17 varies the bias on the control-grid of V9.

The total "A" current is 2.85 amps.; "B," 12 ma. min., and 25 average max. The power output rating of this receiver is 2 watts. This high rating is a result of "push-push" (or "class B") power output, which has been described in detail in past issues of RADIO-CRAFT; notably, the January and February, 1932 issues.

To adjust these circuits, dismount the chassis but do not remove its connections or the flexible cable. Balance the R.F. circuits at 1400 and

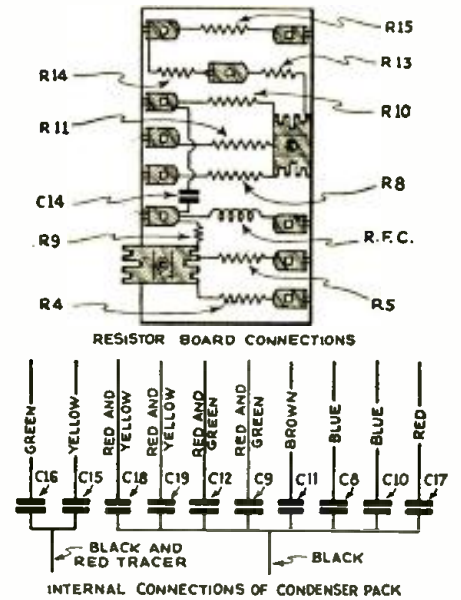

600 kc., using a No. 5 Spintite, and an insulated screw driver. When the dial indicates 150, the tuning condensers should be fully meshed. Padding condenser C4 comes into consideration when the 600-kc. adjustments are being made; its trimmer C4A is then adjusted, while the main condenser gang is rocked back and forth for maximum deflection on the output test meter. During these adjustments, V9 must be removed from its socket.

For the I.F. adjustments, at 175 kc. it is also necessary to remove the chassis from its mounting brackets.

Insufficient volume-control by means of R17 may be due to the use of a tube of wrong constants for V9.

In the receiver, the tubes are arranged in two rows. In one (left to right) they are: V3, V2, V1, V4, V5, V8; in the other: V9, V6, V7.

Resistor R1, 10,000 ohms; R2, 6,000 ohms; R3, 40,000 ohms; R4, R5, 30,000 ohms; R6, 170 ohms; R7, 0.5-meg.; R8, 28,000 ohms; R9, 0.1-meg.; R10, 1 meg.; R11, 3,500 ohms; R12, 4 ohms; R13, R14, 270 ohms; R15, 1,200 ohms; R16, 70,000 ohms; R17, 50,000 ohms.

The Model M-30 receiver has been designed with particular regard to ease of installation and service. Properly installed, freedom from

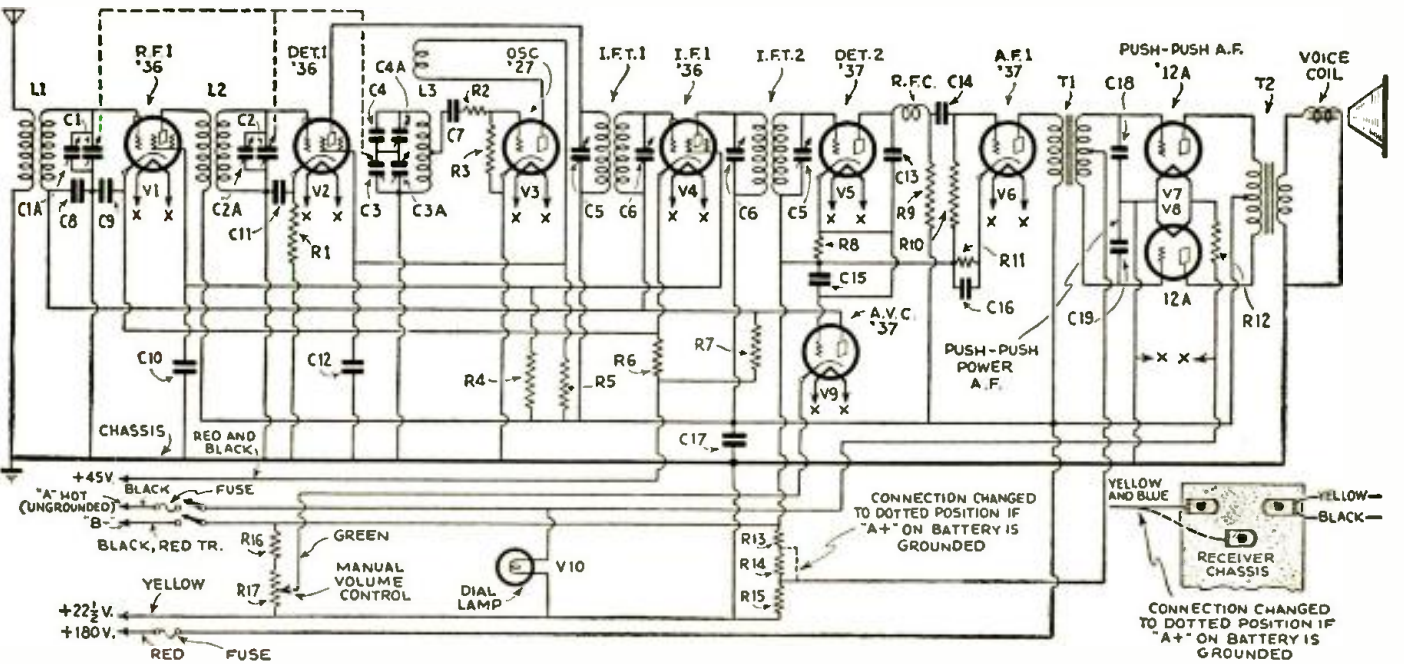

The RADIO CRAFTSMAN'S

The Bulletin Board for Our Experimental Readers

Page

A GENEROUS CORRESPONDENT

Editor, RADIO-CRAFT:

I have been buying RADIO-CRAFT ever since it has been published and, needless to say, I have secured much valuable help and information from its pages.

I am an experimenter to some extent, and I note what Mr. A. E. Ellison, of Ilwaco, Wash., has to say about a 175-kc. "super," using the 2-volt tubes.

I have just built such a set, for my own private use, and from the Pacific Coast have heard KDKA and WABC with good volume on ear phones, and many Middle-Western stations on the loud-speaker.

If this gentleman, or anyone else, would like to have any details, or if you yourselves would care to have the information, I would be glad to send the information along. The set I have assembled will bring in KDKA (980 kc.) alongside of KJR (970 kc.) and XED (961 kc.) between KFWB (950 kc.) and KJR (970 kc.) I expect to get better than this when I finally get the 2-gang R.F. and 1st-Det. condenser lined up.

WLW, WTAM, and WGN come in like locals, when the weather is right, with some noise however, but that should be better later on.

I will be glad to send photographs and circuit diagram to anyone who may be interested.

P. R. HOWARD,

c/o The Mercantile Ins. Co. of America,
315 Montgomery St., San Francisco, Calif.

(The letter of Mr. Ellison, referred to by Mr. Howard, appeared in the November, 1931 issue of RADIO-CRAFT, pages 281 and 308.

We sincerely hope Mr. Howard's poke is well filled with "what it takes," so that he can fill all the requests he will receive in answer to his generous offer.—*Technical Editor.*)

FROM A MINISTER

Editor, RADIO-CRAFT:

You have started me off on Volume III of RADIO-CRAFT, and I like it. What will you give me the first two volumes for? Then I will have it complete up to date and will be sending you my subscription for the future numbers.

Though I am a minister, I consider myself somewhat of a Radio experimentalist and mathematician. I get great glory out of it. It carries me so completely into the realm of the infinite and the divine, and even more so than does the science of astronomy. Then too I realize that I am dealing with scientific facts rather than with the philosophical and suppositional and hypothetical. It adds inspiration and glory to all my scriptural and spiritual understanding of divine and eternal realities concerning the soul.

W. GAYLORD JAMES,

Minister, The First Baptist Church,
188 W. Lorain Street,
Oberlin, Ohio.

(A limited number of RADIO-CRAFT volumes I and II are still available; and at the special "club" rate of \$5.00 for the two.—*Technical Editor.*)

A SCREEN-GRID PORTABLE

Editor, RADIO-CRAFT:

I built the "Pentode Portable" described in the September, 1931 issue of RADIO-CRAFT, but instead of wiring it for use on the A.C. line, I built it as shown in Fig. 1, for use on batteries. I am using a type '32 screen-grid tube and one '33 pentode power tube.

Also, I am using only 90 volts on the plate, and the results are surprising in volume and distance.

I am using a choke coil instead of an old audio transformer; there is no "C" battery; and for smoother control of regeneration I

wired into the screen-grid circuit of the screen-grid tube a 50,000-ohm variable resistor.

There is no difficulty in separating the following stations: WGBF, WSM, WCCO, KSTP, WGN, WSUL, WMT, WMAQ, WFAA, WHAS, KWKH, WOC, WHIO, KMOX, and WENR. Station KMOX comes in almost as loud as WOC, which is only 10 miles away.

I would be very much interested to hear from other experimenters who may have wired the "Pentode Portable" for battery operation.

HENRY F. KOCK,

c/o Kock's Radio Shop, Blue Grass, Iowa.
(One version of a battery model "Pentode Portable" is the initial description in the August, 1931 issue of RADIO-CRAFT; it uses a type '12 tube, and the '33 pentode.—*Technical Editor.*)

AN "INSIDE OUT" TUBE?

Editor, RADIO-CRAFT:

I have among my collection of unusual and antique tubes, one recent addition, a '26, with the standard R.C.A. markings on the base, and with the Cunningham etching inside the glass. Is it a rebuilt tube, a factory "bull," or what?

Perhaps one of your readers has come across a similar case, and can explain the contradictory markings.

RAY HUTCHENS,

50-62 48th St., Woodside, L. I., N. Y.

OH! MR. GOLDBERG!

Editor, RADIO-CRAFT:

I have been a subscriber to your magazine since its inauguration and, to my pleasure and profit, have never missed reading a copy; also, I have had the privilege of seeing in print several of my contributions in the "Radio Kinks" department.

I do not recall anything in the way of burlesque except your two recent ads on radio sets, and I am wondering whether you have ever contemplated a "Nut Idea" department. If so, the idea I am about to present might serve as a starter; and if not, I submit it to you for whatever it may be worth to use as is, or to be elaborated upon.

By way of introduction: to determine the correct spelling or definition of a word, we refer to the dictionary; for other information, we use the encyclopedia, for geography, the Atlas; for dates and events, histories; for what ails us, the patent medicine almanacs or Dr. Brinkley; and so on.

How often does the radio listener hear a song or tune and, having missed the an—
(Continued on page 630)

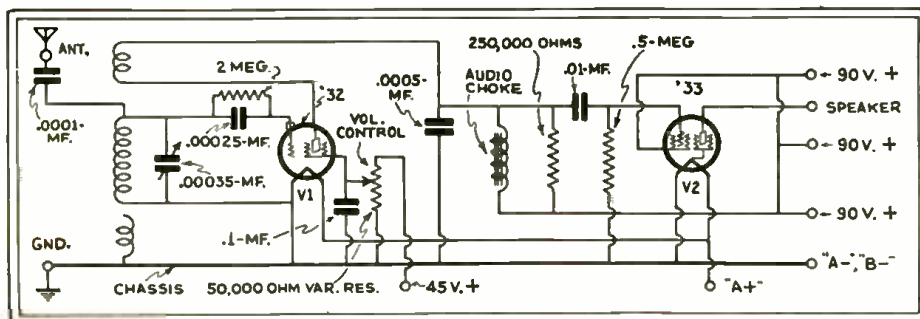

Fig. 1

Mr. Kock's improved circuit arrangement of the RADIO-CRAFT "Pentode Portable."

Some NOVEL RADIO EXPERIMENTS

(PART I)

ONE has only to glance at the chassis of a modern radio set to realize how "wonderfully and fearfully" they are made. Even the wiring diagram looks terribly complex, and yet the principles of radio reception are very simple, and under suitable circumstances may be demonstrated without tubes, crystals, phones—with practically nothing more than an aerial and a tin can. Of course, such methods are not efficient, but they assist greatly in making clear the fundamental principles involved.

The rather unusual experiments to be described call for considerable power, but as there are a large number of broadcasting stations in the country, each with its surrounding population, a great many experimenters will doubtless find themselves favorably situated. In the present case, the experiments were made about a block dis-

By JOHN D. ADAMS

ON this page are described what we call "Novel Radio Experiments." Various means of receiving radio programs without the expenditure of any power in the receiver are described by the author and a brief explanation of the theory underlying each operation is also given.

One point should be borne in mind—in order for the reception, as described, to be duplicated, it is necessary that the receiver be located very close to a powerful broadcasting station—say, for example, within one-half mile of a 10,000-watt station.

In the forthcoming issues of RADIO-CRAFT, additional similar experiments will be described.

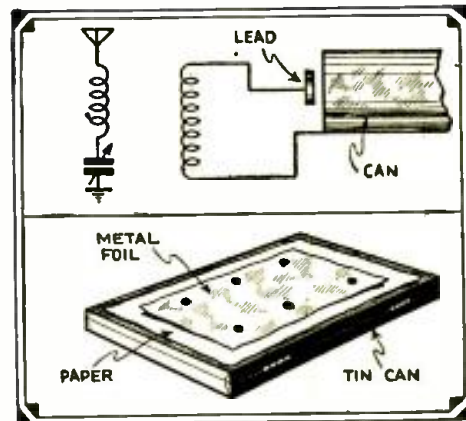

Fig. 5, above. Revised antenna circuit, Fig. 6, below. The "cigarette" receiver.

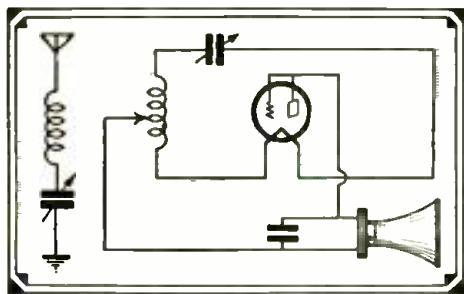

Fig. 7

The filament of this tube receives power from the broadcast station.

tant from a 500-watt station (KTAR) and more than sufficient power was available. As there are now stations having ratings all the way up to one hundred times this amount, a very considerable increase in distance will generally be found practicable.

Requirements

The first requirement in making all possible power available is to provide a good

aerial, a low-loss coil, and a tuning condenser, all connected as in Fig. 1. No definite sizes can be given in regard to the coil and condenser as these will depend on the wavelength of the station being used. In general, however, it may be stated that the resistance of a condenser is higher at the smaller readings, in consequence of which the coil should be planned so that tuning occurs when the rotor plates are pretty well turned in. The coil should be wound with heavy wire—not smaller than No. 18—and have a space between the turns about equal to the diameter of the wire. Bell wire makes a good coil, and if cotton-covered wire is used, some string should be wound with the wire to secure the desired spacing.

To tune the aerial circuit approximately (to see whether the power is on, etc.), the writer makes considerable use of a flashlight lamp, the two terminals of which are connected through a single loop of heavy

copper wire, as illustrated in Fig. 2. When held near, and parallel to, the turns of the aerial coil, the lamp burns very brightly. In fact, one of the small sized auto-lamps lights up to full brilliancy.

Possibly the simplest conceivable installation for radio reception would be to provide an aerial of just the right length (so that neither coil nor condenser would be required for tuning), and then connect the lead-in to a short length of very fine wire, which in turn would connect with the ground wire. This fine wire would talk, and yet crystals, tubes, coils, condensers and phones have all been dispensed with. While we cannot arrange such an aerial without a lot of trouble, the principle can be readily demonstrated by using a tuned aerial, and employing for the fine wire the filament of a '71A or '01A tube.

Construction Details

Bore a hole in the center of the bottom of the base, and then insert the end of a file or a nail, and break off the end of the small glass tube used in sealing off the tube. This admits the air and will let the sound come out if a small rubber tube is run from the hole to the ear. A better way, however, is to drill a hole in the top of the glass bulb, using a piece of 1/4-in. copper tubing with emery powder and a little turpentine.

Do not attempt to drill this hole until the air has been let in at the lower end. The tube may now be held to the ear like a head-phone if flexible leads are soldered to the two filament prongs. The writer experimented with a 483-meter wave, and got good results when the filament was inserted directly in the aerial circuit. With shorter waves, which would require a smaller loading coil, possibly better results would be

(Continued on page 629)

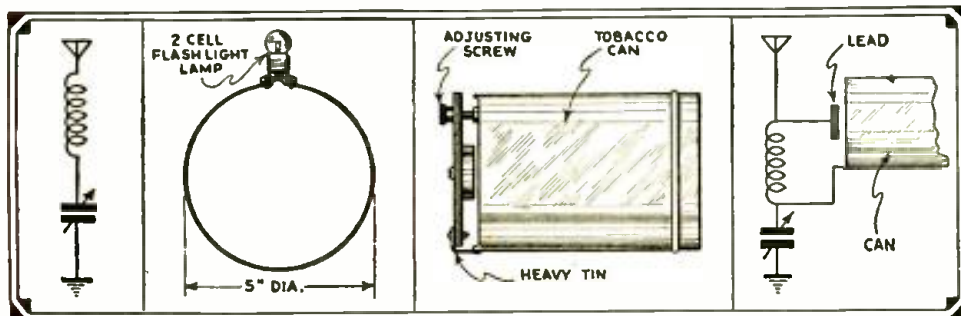

Fig. 1, left. The first requirement of the "powerless receiver"—a low-loss antenna circuit. Fig. 2, left center. The resonance indicator used to tune the antenna to resonance. Fig. 3, right center. An assembly view of the "tobacco-can" receiver. Fig. 4, right. Diagram of connections of the "tobacco-can" receiver.

FIDELITY IN HOME RECORDING

A general description of the factors governing fidelity in home recording

WHEN the kodak camera was first introduced to the public many years ago, it created quite a furor, and people were quite satisfied with the results as long as anything was visible on the print. After the novelty had worn off, the amateurs became more exacting in their demands. The finished product had to be more than a good imitation—it had to be perfect. It was not enough that the snapshot was recognizable, but the surroundings had to be reproduced faithfully and the contrast between the subject and the background had to be exactly like the real thing. This entailed many years of research and development on the part of the manufacturers; today, the camera is so constructed and the film so perfected that even a child can operate a camera and obtain perfect results.

With home recording, the story has been very much the same. The novelty of hear-

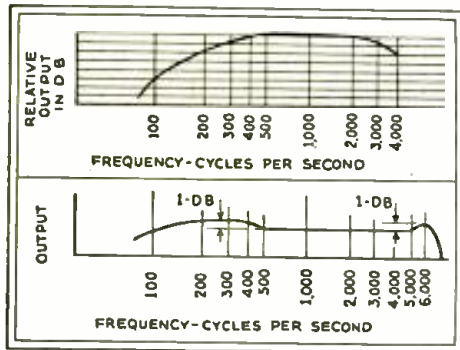

Fig. 1, above. Single-button response curve.
Fig. 3, below. Two-button response curve.

By GEORGE J. SALIBA, S.B.

button carbon, the two-button carbon, and the condenser microphone are all readily adaptable to home recording.

An average single-button carbon microphone has the characteristic shown in Fig. 1. It is noted that this characteristic rises rapidly from 100 to 500 cycles, then flattens out up to about 2800 cycles, and from that point falls off very sharply. In other words, there is a variation of 8 DB between 100 and 2800 cycles. In any electroacoustical device, the maximum allowable difference in level over the entire range is between 2 and 3 DB, and it is readily seen that this type of microphone is not suitable for recording if good results are desired.

While voice may be recognizable through this instrument, the sharp cut-off around 2800 cycles makes it absolutely useless for any musical work. The carbon hiss is another objectionable characteristic—because it makes the letter "s" very hard to reproduce, giving the effect that everyone talking through it has a lisp.

The double-button carbon microphone is the type best suited for home recording. Fig. 2 shows a simple circuit using this instrument. It is easily seen that, as the diaphragm is actuated by the voice waves making it move in either direction, the current through one side of the transformer will increase while the current through the reverse side will decrease.

This effect contributes to the elimination of microphone hiss caused by the normal current flowing through the carbon granules, as well as eliminating distortion caused by even harmonics. It also eliminates any effect of the microphone current upon the transformer, since the battery current flowing through the microphone transformer creates opposing magnetic fields, and there-

fore is balanced out. (This is similar to the action taking place in the primary of the output transformer in a push-pull amplifier.—Editor.) A well-constructed two-button microphone has a characteristic as shown in Fig. 3. The curve is flat, within 3 DB, from 30 to 6000 cycles, and this is more than enough to reproduce all of the

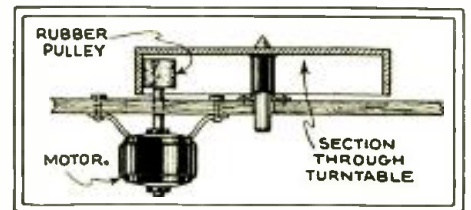

Fig. 7
A simple and inexpensive drive.

frequencies necessary for good recording. No frequency above 6000 cycles is ever put on the air from a broadcast studio.

The condenser type of microphone, no doubt, is the instrument for perfect recordings—but its high cost and the extreme care required in its use make it impractical for the average home-recording enthusiast. Its characteristic is very flat from the lowest audio frequency to well above 7000 cycles. It has no internal noise, and there is no danger of any trouble, such as packing, developing during recording.

The microphone consists in its essentials of nothing but two metal plates. One is a flat brass disk, called the "back plate," and the other is an extremely thin, tightly-stretched circular sheet of duralumin, called the diaphragm. This diaphragm is spaced .001- to .002-in. from the back plate and well insulated from it. These plates together form a small condenser, from which the microphone derives its name. Sound waves striking the diaphragm cause it to

ing one's voice reproduced has worn off, and now the amateur is demanding a record that, when reproduced, will be hard to distinguish from the real voice. It is fortunate for the home-recording enthusiast that present-day apparatus is so highly developed that no real research work is required of the manufacturers to finish apparatus that will make and reproduce a faithful recording. It is simply up to the amateur to obtain this apparatus and to use it in an intelligent manner.

The description and use of apparatus has been discussed in detail in previous articles; it is the purpose of this article to show how the apparatus should be selected and what engineering requirements are necessary for faithful recordings.

Choice of Microphone

In the selection of the microphone, one has a choice of several types. The single-

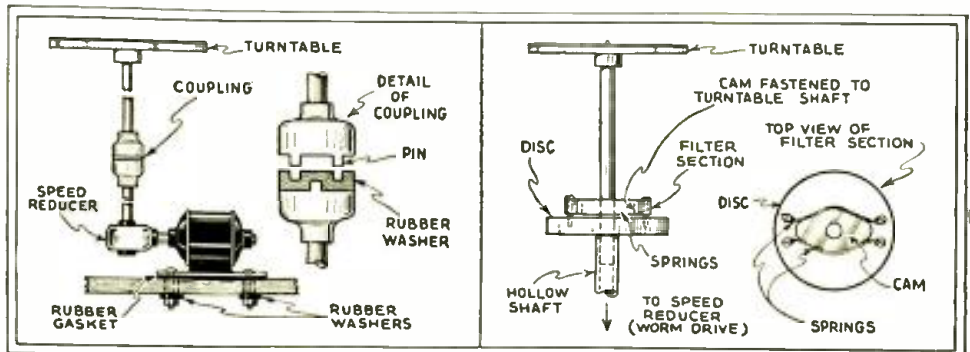

Fig. 5, left. A flexible coupling between motor and turntable "takes up" rapid variations in speed.
Fig. 6, right. In this case, a spring is used to absorb speed variations.

move slightly toward or away from the back plate, and thus vary slightly the capacity of the condenser.

Figure 4 shows a circuit of this microphone with its associated amplifier. Since the capacity of the condenser transmitter is very small, the capacity between the

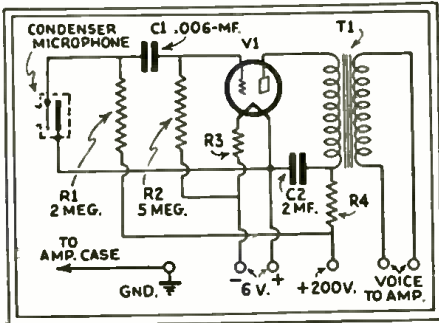

Fig. 4

An amplifier suitable for use with a single-button carbon microphone.

leads from it to the grid of the first amplifying tube must also be kept very small, and that is the reason that the amplifier and transmitter are always built as a unit.

Amplifiers

It has been the custom in the past to say that an amplifier was faithful if its frequency characteristic was flat from the lowest audible frequency to the highest practical audible frequency. In a previous article, the characteristics of amplifiers that were suitable for recording were discussed and the transformer-coupled amplifier was recommended because it gave the most an-

plification for a given investment than any other type. When we start to consider fidelity, we must forget about cost. An amplifier that has a flat characteristic over the entire audible range is the most suitable for a recording system if the finished product is to be reproduced on a very efficient system.

Unfortunately for the home recordist, his reproducing system will not be efficient if he uses the same amplifier for play-back that was used for recording, due to the use of the thorn or fiber needle. This type of needle is notoriously inefficient in the reproduction of the high frequencies. The shape of the needle and the material of which it is made, prevent the fine high-frequency modulations from being reproduced faithfully. As a result, frequencies above 3500 cycles are practically inaudible and this is detrimental to good quality. It can therefore be said that the reproducing system has a drooping characteristic, and to compensate for this, the amplifier must be so constructed that its curve rises to compensate for the falling characteristic of the reproducing end.

Filters

In all previous discussions, the subject of turntables has been treated only from the standpoint of power; that is, the only requirement of the turntable motor was that it have sufficient power to pull the record under the heavy load of the recording head. In addition to this requirement, fidelity imposes other demands. The turntable should run at a uniform speed at all times and should be thoroughly filtered against sudden live changes and vibration.

A good test to determine how a turntable is behaving is to record a sustained note and then play it back on the same table. If the note warbles, that is, has a sort of a tremolo effect, then it is a sure indication that the turntable is not thoroughly filtered. By filtering is meant that there must be no rigid connection between the motor and turntable.

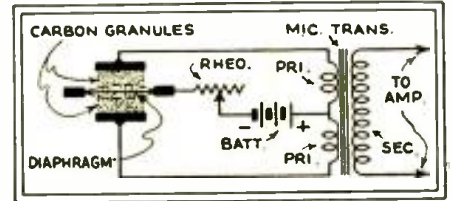

Fig. 2

Connections of a two-button carbon microphone.

Several examples of turntable filters are shown in Figs. 5, 6, and 7. In Fig. 5, the motor is mounted on a rubber cushion and the bolts are run through holes larger than their diameter. A rubber washer is used so that any vibration that is set up by the motor is not transferred to the cabinet and table. The flexible rubber coupling transmits the rotary motion to the turntable and it is thus seen that this coupling absorbs any sudden speed changes in the motor.

Figure 6 shows another form of filtering that is very effective. A hollow tube is driven by the worm gear, and on the upper end of the tube is mounted a disk which has four screws on it. Each pair of screws serves as a mounting for a steel spring. Between these two springs rests an egg-shaped cam which is fastened rigidly to

(Continued on page 631)

DISSECTING A MODERN SET TESTER

(PART III)

By FLOYD FAUSETT*

THIS month, we shall continue with a discussion of the analyzer section of a set tester, the first part of which was discussed in the February issue.

It will be observed that an "A.C.-D.C." toggle switch is connected across the "Multi-Meter" movement for the purpose of adjusting the meter sensitivity for average pulsating and for direct current and potential values, and for root-mean-square (R.M.S.) values in alternating current and potential measurements. All alternating power specifications are usually in terms of "R.M.S." values as measured by ordinary service A.C. voltmeters. For resistance measurements, the "Multi-Meter" is most sensitive when this switch is in the "A.C." position. With this switch in the "A.C." position, the full-scale current of the "Multi-Meter" movement is 360 microamperes. The full-scale movement current is 400 microamperes with this switch in the "D.C." position.

The "Multi-Meter" and its shunts and multiplier resistors are separately calibrated and are interchangeable for replacement or service purposes. The "Multi-Meter" and resistor connections are shown in schematic form in Fig. 3; its power circuit is shown in Fig. 4. It will be observed that the "Multi-Meter" is not in any analytical circuit until a push button is depressed for

the desired reading, thus affording a maximum of protection to the "Multi-Meter" at all times, and enabling the user to connect the meter for any desired test while observing the plate-current reading of the "Milli-Ammeter."

The separate 2-scale "Milli-Ammeter" is included in the analytical and tube-checking circuits for the plate-current readings which are indicated on this meter without requiring any switch manipulations other than depressing the "Lower Scale Mils." push-button for more discernible readings of plate currents less than the lower range of the "Milli-Ammeter."

This arrangement of the two meters provides simultaneous plate-current and potential indications, and eliminates the breaking of the high-voltage plate-circuits by switch action with consequent overloading of the filter systems of radio receivers.

Measuring High-Resistance Circuits

In the design of modern radio receivers, the use of high-resistance coupling circuits introduces errors in practically all voltage measurements, because of the "multiplier effects" of the resistors in the coupling circuits of such radio receivers. Furthermore,

potential measurements will vary with different ranges of ordinary service voltmeters applied to high-resistance circuits, so that the voltage readings published by a radio manufacturer may be found quite different by the Service Man when analyzing with a voltmeter of the same sensitivity but of a different range from that used by the radio manufacturer.

Such differences are much less likely to exist in milliammeter indications, and these factors make it advisable to rely more upon plate-current and less upon voltage readings for indications of amplifier-circuit conditions. During the analysis of a radio tube-socket, a normal plate-current reading generally indicates that the proper potentials are applied at all terminals of the socket being analyzed, so that a more rapid analysis can be made of the radio by undertaking current measurements only.

When the manufacturer's data pertaining to a particular radio are not available, a radio man can determine from the tube manufacturer's data the plate-current specification for a particular type of tube for normal operating purposes.

The probable circuit defects corresponding to various plate-current variations are tabulated in the complete instruction booklet which accompanies the Diagonometer.

(Continued on page 620)

* Chief Engineer, Supreme Instruments Corp.

A New S.-W. Receiver

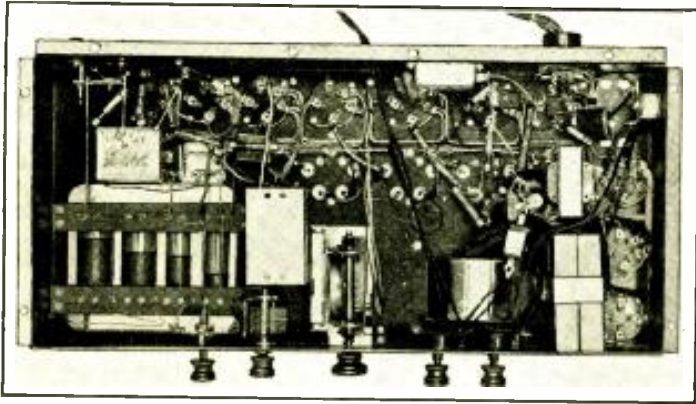

Fig. A

THERE is much justification for automatic volume-control in short-wave radio receivers to eliminate the effects of fading, but it must be borne in mind that it is no panacea for all fading troubles. To begin with, of all the so-called automatic volume-controls found on commercial broadcast receivers today, only one has been anywhere near true automatic volume-control—and that example has been obsolete for a year and a half or more. Such "automatic volume-controls" as are found today are "blast eliminators" only, for they will not hold power-output constant for normally wide variations of signal voltage, which is the prime requisite of automatic volume-control.

True automatic volume-controls have three disadvantages. The first is that receiver sensitivity rises automatically to a maximum between signals, so that as the set is tuned between signals it sounds terribly noisy. The second disadvantage is that if it holds constant the volume on a fading signal, the noise level must fade up and down behind the signal if it is at all weak, since a fading signal will almost invariably fade through a range of from quite close to—or below—the noise level, to well above it. Such a condition does not make for enjoyable reception, as the third drawback likewise does not. Signal fading is usually caused by ground and sky waves arriving at the receiver progressively in and out of phase, and this often results in serious side-band, or modulation, distortion as well as varying volume. Automatic volume-controls can only hold volume constant, or nearly so, at best, and cannot correct varying distortion, or, relatively, varying noise level.

It has been believed best to include it in the receiver described here, since much of the extreme distance-reception of short-wave sets is indulged in for thrill rather than entertainment, and if automatic volume-control can in any measure facilitate logging the call of a station many thousands of miles away, even though it may not be

able to make for an enjoyable program, it is of enough benefit to justify its inclusion.

Description of Receiver

In the March, 1932 issue of *RADIO-CRAFT*, the receiver (S-M 727) embodying the development described above is illustrated by photograph, and its circuit diagram is shown in Fig. 2. In the current article, the receiver is further illustrated by Fig. A, and its operating curves are shown in Figs. 3, 4, and 5. It is a ten-tube, all A.C. superheterodyne having but one tuning dial to tune from 16.5 to 550 meters, or 18,000 to 550 kc. Basically, the circuit consists of a tuned '24 screen-grid first-detector, tank-tuned '27 oscillator, '27 harmonic generator tube, two stages of 465-ke. dual tuned (ganged), or Siamese, '51 vario-mu I.F. amplification, '27 automatic volume-control tube, '27 second linear power audio-detector, push-pull '47 pentode output stage and '80 rectifier.

Starting at the left of the circuit diagram, Fig. 2, there is seen what appears to be a quite complicated switching arrangement, which, however, is actually very simple. The double-bladed switch serves to connect the '24 first-detector grid either to the secondary of the broadcast-band antenna transformer, to which is permanently connected the proper section of the gang tuning condenser, or to successively connect it to one of the four short-wave antenna coils; and in each case, to pick up the short-wave tuning condenser, a 200-mmf. midget type, which is the auxiliary, or trimmer, tuning adjustment for short waves. The upper switch serves only to disconnect the antenna from the broadcast-band primary and to reconnect it to the first-detector grid through a permanently-adjusted antenna compensating condenser for short-wave operation.

For broadcast-band reception, the '27 oscillator is directly coupled to the '24 first-detector by a small coupling coil in the first-detector cathode lead, while for short

(PART II)

In the preceding issue of *RADIO-CRAFT* appeared Part I of this description of a new design in all-wave superheterodyne receivers. Its particular feature is the use of only one coil in the oscillator; its harmonics permit coverage of the 16- to 550-meter band.

waves the oscillator is coupled to the proper short-wave coils by small coupling coils, all in series, in the '27 harmonic generator's plate circuit. The lower portion of the switch, therefore, serves only to include this oscillator coupling coil in the first-detector cathode lead for broadcast-band reception, or to cut it out of the circuit for short-wave reception. Actually, the upper and lower sections of the switch in Fig. 2 are only S.P.D.T. switches in action, but are physically five-point switches in order that they, being ganged to the main band-selector switch, may maintain one set of connections throughout four successive positions of the coil selector switch.

It will be noted that the single tuned broadcast-band circuit preceding the first-detector employs an extremely efficient inductance of fairly large size, insuring an excellent ratio of image-frequency selectivity, as well as making for a 2 to 1 increase in signal-to-noise ratio as against the use of a Siamese, or dual pre-selector circuit. The short-wave antenna circuit is likewise single tuned, and because the tuning range of each of the four short-wave antenna circuits is considerably wider than the harmonic range of the oscillator which it is initially intended to utilize, and as this antenna circuit is separately tuned, it is possible to utilize either of the two possible oscillator points for any desired signal, and to develop other combinations of dial settings for a short-wave signal (say between 16.5 and 40 meters). If this condition existed in the broadcast band, it would be a serious drawback, but on the sparsely populated short-wave bands, it permits the choice of an optimum point for any given station at will, and is an appreciable advantage.

In examining the first-detector circuit, two bypass condensers will be noticed shunting the bias resistor R1, one a .1-mf. paper condenser, and the second, a smaller mica condenser. The reason for this is that the larger value is desirable on the broadcast band, but its impedance rises too high on the very short waves, so it is additionally

* President, Silver-Marshall, Inc.

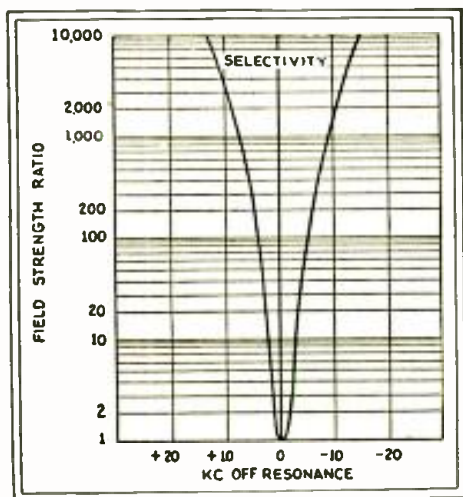

Fig. 4
Selectivity graph of the Silver-Marshall Model 727 receiver.

shunted with a capacity satisfactory for the very short waves.

The oscillator circuit is a typical tank-tuned arrangement such as is found in all this year's S-M sets, and needs little special description. To its plate circuit is coupled the grid of the harmonic generator tube V3, with, of course, an isolating condenser, and grid resistor. This tube is biased well below the cut-off point, so that it would normally draw no plate current, by the bleeder resistor and auto-bias resistor close to it in the diagram. It draws plate current, however, since the oscillator is always feeding it voltage, but it generates the harmonics used for heterodyning on the short waves as a result of its excessive bias. It is operated at a full 180-volt plate potential, while the oscillator tube is fed through a resistor resulting in an operating plate potential of about 90 volts as is customary.

The I.F. Amplifier

The I.F. amplifier is not particularly unusual, unless it is in the use of "Litz" coils in order to obtain a high degree of selectivity at its frequency of 465 kc. All these transformers are dual tuned, the gain per stage being between 90 and 100 with the '51 variable- μ tubes used.

The automatic volume-control tube is seen in the diagram just below the two I.F. tubes. It functions as a rectifier actuated by the I.F. carrier voltage. This it rectifies and applies to the I.F. control grids, this operation serving to maintain a balance between the signal voltage appearing at the second, or audio, detector grid and varying signal inputs. Its grid is coupled to the plate of the second I.F. tube through a condenser C19 and R.F. choke, while all audio modulation originally appearing on the signal carrier is filtered out by an audio filter consisting of a resistor in its plate lead and two bypass condensers. This is necessary, since it is actuated by a modulated I.F. voltage, yet must turn out a substantially pure D.C. biasing voltage for the I.F. tubes.

This system of automatic volume-control is just exactly that, for it will hold all signals from about 20 microvolts absolute on up to constant output, and it is in no sense a "blast eliminator" such as is usually found

masquerading as automatic volume-control.

Because of its perfect operation, it is impossible to tune accurately to the peak of a carrier by ear, since in tuning it will cause response to appear rectangular in terms of dial readings against volume. For this reason, a tuning meter is included in the circuit. This meter is in the cathode lead of the I.F. tubes and, besides serving to provide an initial "C" bias, reads their plate current, plus carrier voltages, as the set is tuned. Thus, by means of observing carrier deflections on this meter, the set can be accurately tuned to a signal without the distortion that might result if it were tuned only by ear, and some side bands cut if this were not done accurately (due to the extreme selectivity of the I.F. amplifier).

The output voltage of the automatic volume-control tube is developed across a resistor R18 between its plate and ground, the resistor being included in the grid returns of the I.F. tubes. Thus, with a signal so weak as to develop no voltage across this resistor, the I.F. bias is low and sensitivity a maximum. On a strong signal, the rectified voltage runs the I.F. grids negative to a balance point, which represents full output of the second-detector.

Obviously, volume control cannot be in the R.F. portion of the circuit if the operation of the automatic volume-control is to be unhampered, and it, therefore, takes the form of an audio control—a potentiometer in the second-detector plate circuit.

Because the sensitivity of the set, but not its volume, is controlled entirely by signal strength, it will jump to maximum sensitivity between signals and, in consequence of the very high sensitivity, show a quite high noise level on no signal. As soon as a signal is received, this noise drops out except in the case of very weak signals, when the signal-to-noise ratio will be what would be had without A.V.C. An A.V.C. does not boost noise in any way of itself, but it does make it more apparent between signals due to the automatic rise of sensitivity when no signal is tuned in—which is another way of saying that it facilitates reception of weak stations since it automatically boosts sensitivity for them.

Examining the photograph in the March, 1932 issue, the chassis is seen with the top of the large shield housing the gang condenser and all coils but the oscillator removed. The four short-wave coils are clearly visible, as are the gang condenser, 600-kc. oscillator trimmer screw adjustment, and the quite large broadcast antenna coil, with its small oversize primary visible in its center. The tubes are, right to left, '27 harmonic generator, '27 oscillator, '24 R.F. or first-detector, two '51 I.F. tubes, '27 audio detector, '27 A.V.C. tube, two '47

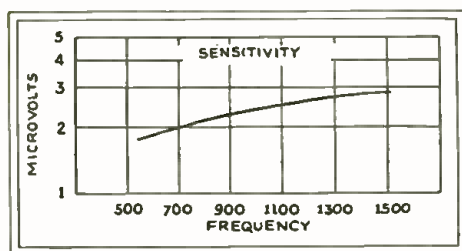

Fig. 3
Sensitivity graph of the "727."

pentodes and '80 rectifier. The tuning meter is seen above the dial (actually, centered over the dial), and the I.F. transformers in the three, round aluminum cans, their trimmers accessible from below. The power transformer is to the left of the dial, and the audio transformer at the left rear.

Looking at the bottom of Fig. A, the placement of parts is reasonably self-explanatory, the wave-change switch is seen next to the short-wave antenna tuning condenser, and behind it the shielded oscillator coil. The antenna compensating (series) condenser is seen at the left-rear corner of the chassis, near the antenna and ground binding posts. The control arrangement seen from the front is, left to right, on-off switch and volume control, tone control, tuning, short-wave antenna tuning, and five-point range-selector switch.

The dial is divided into five differently colored sections, corresponding from left to right, to the five successive positions of the

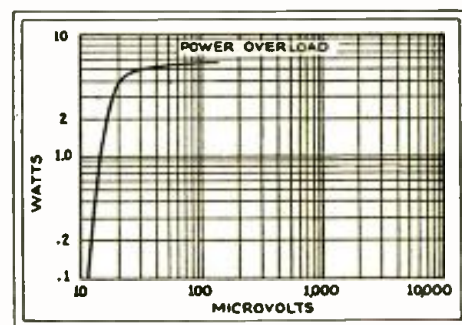

Fig. 5
Overload graph of the S-M 727.

range-selector switch. The four left, or short-wave, sections are calibrated directly in megacycles, and the right section in kilocycles from 550 to 1500 kc., less the final zero, or from 55 to 150. This greatly facilitates tuning, and reduces "hunting" to setting the dial to the desired point and simply adjusting the short-wave antenna trimmer for greatest noise or loudest signal for any setting of the dial.

In Figs. 3, 4, and 5 appear performance curves of the set. From Fig. 3, the sensitivity is seen to vary from 1.8 to 2.8 microvolts absolute, which is fully adequate for any American location. (Actually these figures have been made low—as low as any set that is ever passed by inspection, practically all being held to less than one microvolt absolute.) Fig. 4 shows a band width of 28 kc., 10,000 times down, which simply means absolute 10-kc. selectivity.

Figure 5 is quite interesting, indicating the power output in watts plotted logarithmically (as it sounds to the ear) against microvolts input. It will be seen that the power output reaches practically a maximum at 20 microvolts absolute input, and remains constant (at whatever the volume setting may be) from there on up. The fidelity curve is flat to a couple of decibels from 40 to 4000 cycles, and then falls off very sharply indeed to insure absolute 10-kc. selectivity and freedom from hiss.

An afternoon and evening of playing with the set in Chicago will bring in at least one broadcast station for every dial degree, also, police stations all over the country, plane to ground conversations, television

(Continued on page 632)

RADIO-CRAFT KINKS

Practical hints from experimenters' private laboratories.

(PRIZE AWARD)

A DYNATRON VACUUM-TUBE VOLTMETER

By C. W. Melotte

IN Fig. 1 is shown the wiring diagram of a vacuum-tube voltmeter I use. Its advantage is that very small voltages can be measured with it without the use of an ultra-sensitive meter.

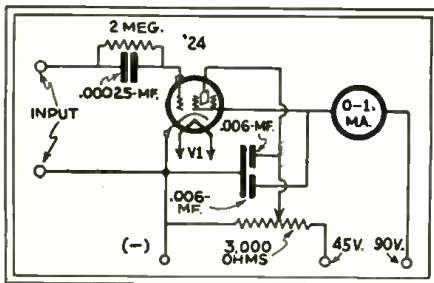

Fig. 1

A "dynatron" V.T. voltmeter circuit.

An ordinary 0-1. milliammeter is sensitive enough to measure such small voltages as would not operate an ordinary V.T. voltmeter using the more standard three-element tube. An input of 0.05-volt gives a reading of approximately 0.2-ma.

The potentiometer is used to accurately adjust the plate voltage to the correct operating point.

(Fundamental constructional data on V.T. voltmeters are contained in the article, "A Gooseneck-Type V.T. Voltmeter," which appeared in the February, 1932 issue of RADIO-CRAFT.—*Technical Editor.*)

A VOLUME-CONTROL METHOD

By Vincent Campbell

IAM writing this "Kink" not knowing whether the method to be described has been used before.

Recently I decided to build a four-tube regenerative receiver which I knew would give me excellent volume and tone. But here arose the problem of obtaining a real volume control. Of course I tried the antenna control and "B" lead control, but all I could obtain was a continuous whistle.

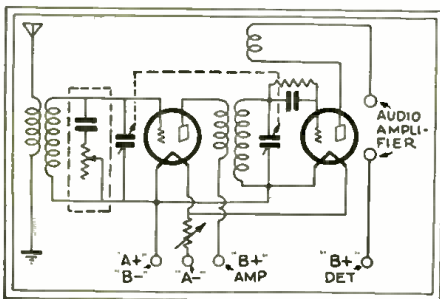

Fig. 2

Mr. Campbell's idea of good volume control.

\$5 FOR A PRACTICAL RADIO KINK

As an incentive toward obtaining radio hints and experimental short-cuts, RADIO-CRAFT will pay \$5.00 for the best one submitted each month. Checks will be mailed upon publication of the article.

The judges are the editors of RADIO-CRAFT and their decisions are final. No unused manuscripts are returned.

Follow these simple rules: Write, or preferably type, on one side of the sheet, giving a clear description of the best radio "kink" you know of. Simple sketches in free-hand are satisfactory, as long as they explain the idea. You can send in as many kinks as you wish. Everyone is eligible for the prize except employees of RADIO-CRAFT and their families.

This contest closes on the 15th of every month, by which time all the Kinks must be received for the next month.

Send all contributions to Editor, Kinks Department, c-o RADIO-CRAFT, 98 Park Place, New York City.

After some time, I finally hit upon the method to be described which gives control ranging from the merest whisper to terrific volume. Perhaps you could use it in your section.

The section outlined in dotted lines in Fig. 2 is the control. I have used a Centralab 500,000-ohm modulator and a .02-mf. fixed condenser. The positive "A" and negative "B" lead connects to the center post of the resistor; the condenser on the end of the resistor to the grid of the R.F. coil, as shown.

Here's hoping you can pass this on to anyone who wants a good volume control.

A UY PLUG-IN COIL

By W. G. Ruppenthal

PERHAPS this method for constructing a UY plug-in coil will interest other readers.

The base is cut as indicated in Fig. 3 so that it is a tight fit in the fiber tube used for the coil form. A circle with a 3/8-in. radius is drawn in the center. A horizontal diameter is then drawn, and where it intersects each side of the circumference of this circle, a mark is made. From each of these two points, arcs are drawn with 3/8-in. radii in order to intersect the circle above the diameter.

From the center, a vertical line (90 degrees from the horizontal diameter) is dropped until it also intersects the circle. These five points of intersection are drilled for either 6/32 or 4/32 machine screws;

if 6/32 screws are used, the threads will have to be filed off a little where they go into the socket. The manner of winding the forms is left to the constructor.

Small holes are drilled in the base to let the coil leads out. Holes 1/16-in. in diameter are drilled through the fiber into the base, and wooden pins are then driven

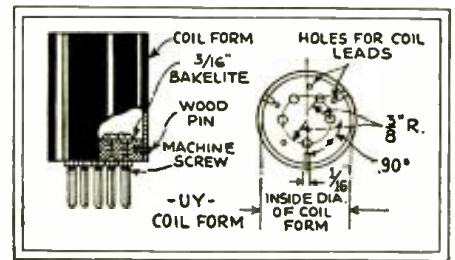

Fig. 3

Mounting coil-tubes to a plug-in base.

in and cut off flush to hold the base and coil rigid if there should be any tendency for them to separate.

A PHOTO-TUBE RELAY FOR UNIVERSAL OPERATION

By C. H. W. Nason

ONE of the writer's friends is a stage designer. He builds pretty models of stage sets with trick lighting effects. The other night he suggested that a photo-electric relay would be a nice adjunct to one of his display sets. The trouble was that the "gadget" had to operate on either A.C. or D.C., regardless.

A few moments of thought followed by a half-hour or more of intensive soldering resulted in the arrangement shown in Fig. 4. It will be noted that the new '37 automotive tube with a heater operated at 6.3 V., .3-A., is used. The filament is lighted through a series resistance and the device may thus be operated on either A.C. or D.C. 110-volt supply circuits.

The grid bias is made variable by means of a potentiometer connected between cathode and ground. This should be adjusted so that the relay does not trip under normal light conditions. This permits the room to be illuminated without such indirect illumination of the photo-cell affecting the operation.

(Continued on page 633)

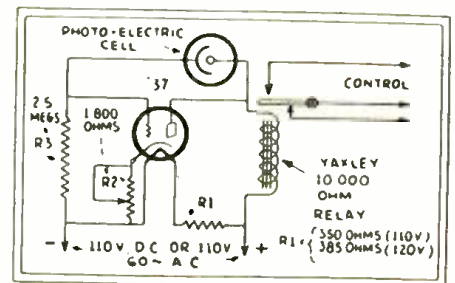

Fig. 4

A P.E. tube relay for A.C. or D.C. mains.



McMurdo Silver
presents

COLOR-TUNING

SHORT-WAVE



LONG-WAVE

Model 727SW

ONE DIAL—CALIBRATED
NEW PATENTED CIRCUIT*
TRUE AUTOMATIC VOLUME CONTROL
METER-TUNING
FRACTIONAL MICROVOLT SENSITIVITY
ABSOLUTE 10KC SELECTIVITY
PENTODE—VARIO-MU TUBES

Price, for Chassis and Speaker
\$99.50 List. Write for discounts.

★727SW is fully covered by Patents Applied For and all infringements will be vigorously prosecuted.

SILVER-MARSHALL, Inc.

6419 W. 65th St.

CHICAGO, U. S. A.

SILVER-MARSHALL, Inc.

6419 W. 65th St.
Chicago, U. S. A.

Please send me all details on 727SW and latest catalogue.

Name.....

Address.....

Radio-Craft's Information Bureau

SPECIAL NOTICE TO CORRESPONDENTS: Ask as many questions as you like, but please observe these rules:

Furnish sufficient information, and draw a careful diagram when needed, to explain your meaning; use only one side of the paper. List each question.

Those questions which are found to represent the greatest general interest will be published here, to the extent that space permits. At least five weeks must elapse between the receipt of a question and the appearance of its answer here.

Replies, magazines, etc., cannot be sent C. O. D.

Inquiries can be answered by mail only when accompanied by 25 cents (stamps) for each separate question. Other inquiries should be marked "For Publication," to avoid misunderstanding.

SEARS, ROEBUCK 4-TUBE MIDGET RECEIVER

(153) Mr. T. T. Carlyle, Houston, Texas.

(Q.1) Kindly print in the Information Bureau of RADIO-CRAFT the schematic circuit of the Sears, Roebuck midget radio receiver which employs only four tubes, including the rectifier; a band-selector is part of the design. The first tube is a type '35 or '51 variable-mu, which functions as first R.F.; this is followed by the detector, which is a screen-grid type '24 tube; the last tube in the receiver portion of the circuit is a type '47 pentode, resistance-capacity coupled to the detector; the rectifier is an '80.

(Q.2) Is there any convenient method of changing the tone of the output? On some types of programs there is a slight "drummy" effect.

(A.1) In Fig. Q.153 is shown the schematic circuit of the Sears, Roebuck 4-Tube Midget Receiver.

Operating potentials are to be measured at a line voltage of 110 and with the volume control full on; the readings (on a Weston Model 547 set-checker) should approximate the following figures: Filament potential, V1, V2, V3, 2.4 volt; V4, 5 volts. Plate potential, V1, 250 volts; V2, 65 volts; V3, 230 volts. Control-grid potential, V1, 2.5 volts; V2, 2.5 volts; V3, 16.5 volts. Plate current, normal, V1, 4 ma.; V2, 0.4-ma.; V3, 35 ma.; V4, 30 ma. (each plate). Screen-grid potential, V1, 90 volts; V2, 37.5 volts*. Space-charge grid, V3, 250 volts. Readings (*) are comparative only, and are not true potentials, due to the resistance of the meter.

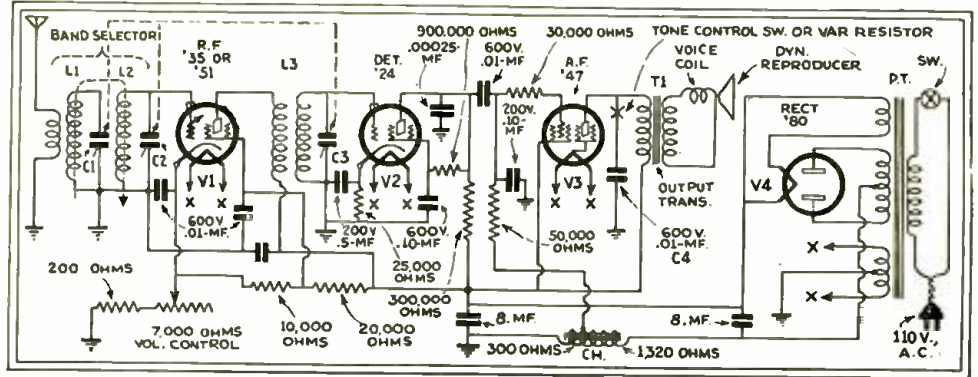

Fig. Q. 153

Sears, Roebuck Company's Midget Receiver circuit, incorporating a variable-mu '35 R.F. tube, screen-grid '24 detector, and '47 pentode, and showing, at "X" the manner of adding tone control.

Adjust the length of the antenna to the requirements of individual localities. To take advantage of the adjusting vanes on the variable condensers (from front to back, they are in this order: C1, C2, C3), the circuit should be aligned at 1,500 kc., 1,295 kc., 800 kc., 750 kc. and 550 kc. The degree of band selection is determined by the inductive coupling of coils L1 and L2.

(A.2) The receiver diagramed in Fig. Q.153 is exceptionally well balanced for the reception of most programs; however, in some instances it may

be desirable to increase the proportion of "highs" in the reproduction. This may be conveniently accomplished by changing the effective value of the output bypass condenser C4 by connecting in series with it, at "X," a variable resistor of 0-50,000 ohms; of course, an off-on switch may be used instead, if satisfactory tone results when this portion of the circuit is open-circuited.

THE GAROD E-6, USING THE '99 AND '10

(154) Mr. Carl E. Feltingham, Akron, Ohio.

(Q.1) There has recently come into the shop for service a Garod E-6 receiver for which it does not seem to be possible to locate a service diagram. Any assistance in this matter will be greatly appreciated. The chassis utilizes one of the old type '99 tubes as a detector, and a type '10 tube in the power output circuit. What are the connections of this receiver and power pack?

(A.1) In Fig. Q.154A appears the schematic circuit of the receiver chassis; the power pack is Fig. Q.154B; the cable connections are shown in Fig. Q.154C. All available parts values appear on the diagrams.

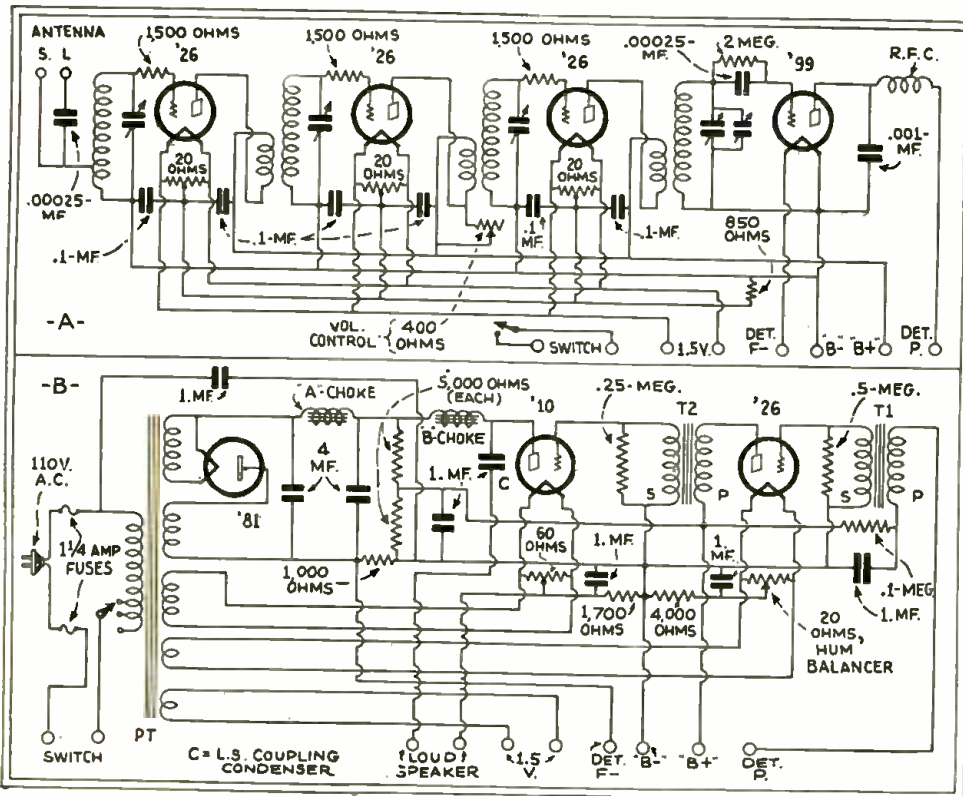

Fig. Q. 154

At A, above, the schematic circuit of the Garod E-6 receiver, which incorporates a type '99 detector. At B, below, the diagram of the E-6's power pack; the power tube is a '10.

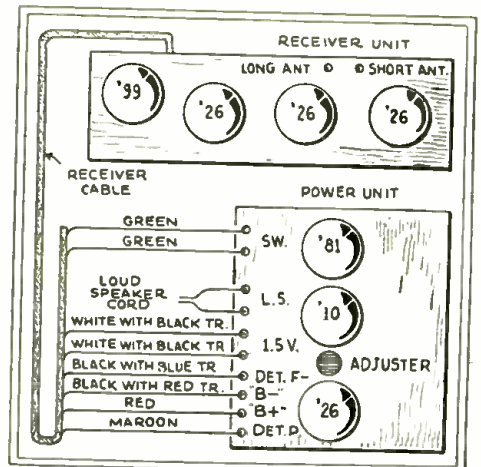

Fig. Q. 154C

Receiver-to-power-pack cable connections of the Garod Model E-6 set.

Only **\$37.50**

COMPLETELY ASSEMBLED WITH LARGE DYNAMIC SPEAKER!

Pentode Variable-Mu and Real Automatic Volume Control

11-TUBE Super-Het.

RADIO FANS! What a radio! A powerful new 11-tube super-het at an unbelievably low price. Reception equal to fifteen ordinary tubes—in a perfectly balanced, non-oscillating, non-radiating, super-heterodyne TEN-TUNED circuit with real automatic volume control that holds those powerful locals down to the same volume as the distant stations and counteracts that annoying fading on weak stations. Two Push-pull Pentode power output tubes with twice the power and four times the sensitivity of ordinary 45's—and Multi-Mu tubes, together with a -24 first detector, gives you SIX SCREEN GRIDS. These six screen grids, together with the -27 oscillator second detector, first A. F., and automatic volume control—the -80 tubes—gives total of ELEVEN TUBES. The use of a band-pass or pre-selector stage, together with Multi-Mu full range tubes, make this radio actually surpass 10 K. C. selectivity. Absolutely eliminates those noisy singing "birdies" and annoying cross talk. You'll be positively amazed and delighted when you see this sensational new set—hear the beautiful mellow, cathedral tone—know what it means to have that pin-dot selectivity and unequalled sensitivity together with true tone fidelity.

Be convinced—TRY A MIDWEST 30 DAYS BEFORE YOU BUY. Don't send a penny. Mail coupon right now for amazing FREE trial offer and complete details. You'll be surprised.

ALL-WORLD—ALL-WAVE



Midwest now offers, if desired, ALL-WORLD—ALL-WAVE reception. The new self-powered Midwest Converter with a powerful 9 or 11 tube super-heterodyne brings in short and long wave broadcasts from everywhere—15 to 550 meters.

Buy Direct--SAVE UP TO 50%

Never before in the history of radio have such powerful sets been offered at Midwest's amazing low prices. Deal direct with the big MIDWEST factory and save the jobber's profit. Your outfit will reach you splendidly packed, rigidly tested with everything in place ready to plug in. No assembling! Entertain yourself for 30 days absolutely FREE—then decide. Save up to 50 per cent in buying direct from factory—insure satisfaction—deal direct with the world's veteran radio builder—MIDWEST. And don't forget—every MIDWEST outfit is backed by an absolute guarantee of satisfaction. You take no risk.

MIDWEST RADIO CORP.
 Dept. 60 (Est. 1920) CINCINNATI, O.

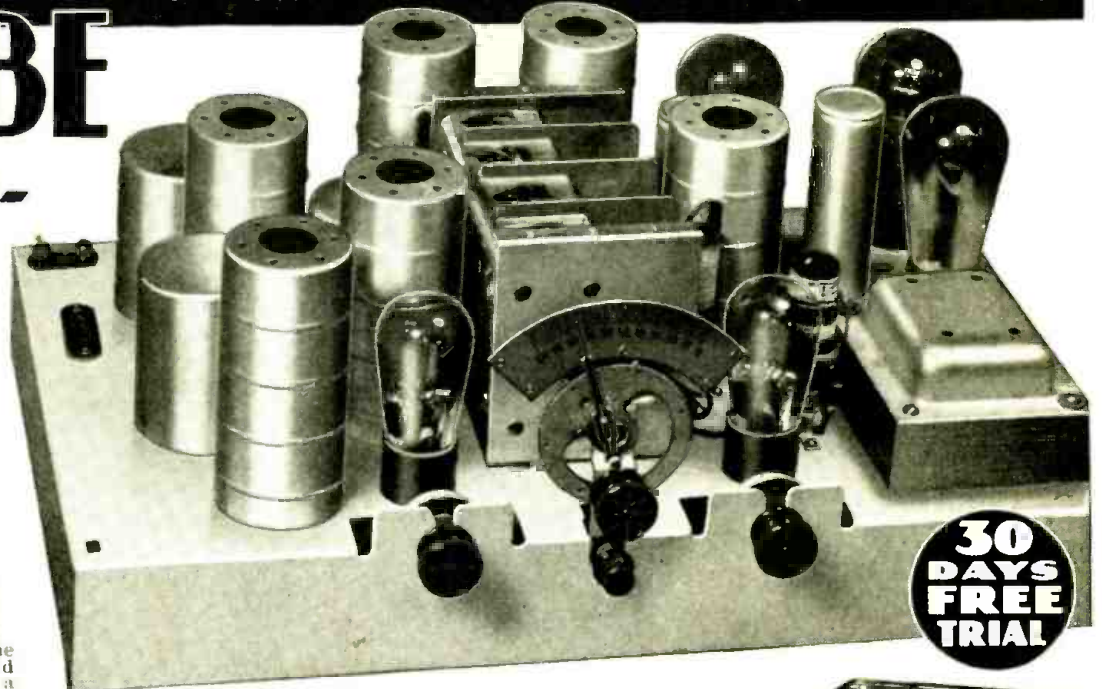

30 DAYS FREE TRIAL

TERMS
 as low as
\$5.00 DOWN

Read This!

New Zealand User Hears New York and Other Stations Eight Thousand Miles Distant

"I would stack my Midwest up against any other make of set on the market. I have a log of 111 stations. Midwest gets 'em all over the world." 36 stations in New Zealand, 34 Austrian, 10 in Japan, 1 in China, 2 in India, 1 in Czechoslovakia and Bratislava, 2 in Honolulu, and a total of 56 stations in the U. S. A., including New York, Cincinnati and Los Angeles. I have received WTIC on two different frequencies . . . also Siam 'Radio Bangkok.' This is a log which would be hard to eclipse by any other set of any power."

FRED W. MORLEY,
 Hawke's Bay, New Zealand.



Complete Line of Consoles

The big FREE catalog beautifully illustrates the complete line of gorgeous Midwestern Consoles. "Deluxe," Highboy and Lowboy models.

RUSH THIS COUPON FOR AMAZING FREE TRIAL OFFER AND BIG BEAUTIFUL CATALOG

MIDWEST RADIO CORP.,
 Dept. 60, Cincinnati, Ohio.

Without obligation send me your new 1932 catalog and complete details of 13 and 15-tube All-World, All-Wave Combination, 4-tube Converter, 9 and 11-tube Super-Heterodynes, low factory prices, easy terms and liberal 30-day free trial offer. This is NOT an order.

Name

Address

Town State

Send me SPECIAL USER AGENTS PROPOSITION

CONFIDENCE

(ENGLISH READING)

RADIO TUBE TESTER



Patented
1932

\$59.50 Net

FOR REPLACEMENT
TUBE
MERCHANDISING

JEWELL 3 1/2 INCH METER USED

The Confidence Portable Radio Tube Tester is the latest advancement in the Art of testing tubes—it is marvelous—select your tube, press two buttons and in English it tells the condition—emission, spacing of elements, plate impedance, presence of gas—in fact everything necessary to know about the condition of a tube, all predetermined and interpreted into English. Originators of BAD—GOOD—GAS readings. Indicates on one jeweled lamp every possible short in a tube. High resistance cathode to heater shorts indicated.

This is the first scientific merchandiser of radio tubes—simple of operation—fool proof and has the confidence of your customers.

Take advantage of the free trial offer and unconditional factory guarantee.

Manufactured by
APPARATUS DESIGN CO., Inc.
LITTLE ROCK ARKANSAS



Counter type \$59.50 net. Meter faces customer otherwise the instrument is same as Portable except it is housed in an attractive black leatherette covered counter housing. Placards are mounted on side panels reading "Free Tube Testing."

Also a special utility counter housing can be supplied at \$10.00 for quick insertion or withdrawal of Portable instrument for counter use.

Buy through your jobber or ask us about free trial plan and also easy payment plan.

Also Free Tube Sale Plan
Printed Matter

GRIEF *and* RADIO SERVICE

By D. V. SIMPSON

DURING the eight or nine years I've been servicing radios, I've spent quite a bit of seemingly unnecessary time trying to locate trouble which I thought complex—only to find a broken wire or bad connection which I, in my chagrin, thought should have been found immediately. Perhaps it should, but it wasn't! Unlike the "old days," it is now necessary, with the A.C. sets and much more complex circuits, to have a fairly complete array of test equipment. Some of this is used daily, and some only occasionally, but, indispensable as these instruments are, one almost daily runs across trouble which is practically impossible to locate by means of set analyzers, etc.

Take, for instance, the set that checks perfectly on a plate voltage, milliamperes drain, bias voltages and, in fact, everything that the most elaborate analyzer can tell us. Still the output is very weak, or perhaps there is no output at all. Of course, we now look at the aerial and ground and all connections leading to them (not neglecting the lightning arrester by any means), and very often we find the trouble there. But, if all these seem O.K., many of us are inclined to sit down, wipe the perspiration from our collective brows, look cross-eyed at the blooming thing—and wonder if there'd be any chance to get on the city street-cleaning gang!

Well, in a case of this kind, it's time to start "poking." A good thing to carry in the inside pocket of one's coat (it *could* be carried in some other pocket) is a stick or fiber rod of small diameter, six or eight inches long. With this instrument one can dig around in the "innards" of a set to one's heart's content without danger of blowing tubes or doing other damage. (This precaution is especially necessary in the case of battery-operated sets. Of course, we learned years ago not to poke with a screw-driver.) In many cases one will find a soldered connection that looks perfect, and may be a very good mechanical joint, but which, because of a too-cold soldering iron in the hands of the set wirer, or by reason of the wrong kind of solder (acid? we certainly hope not!) presents a very high resistance to radio-frequency current. If only *one* joint of this kind is found, it is very good policy to go over all soldered connections in the set with a good hot soldering-iron. This may save a recall on the job.

Sometimes it is possible, by merely exerting a slight pressure upon different parts of the set chassis, to cause it to stop playing. In a case of this sort it would seem a simple matter to locate the bad connection or ground; but such is not always the case. I well remember a five-tube, dry-cell radio of a type very popular a few years ago, on which I worked intermittently for two or three days before I found all of the trouble. This set would play as sweetly as you please for perhaps several days; then it would stop, dead as the grandfather's clock in the song. The owner had found that, by raising one corner of the panel (it was

mounted in the top of a phonograph cabinet) and placing several layers of paper under it to keep it raised, he could usually keep it going. But it seemed to him a trifle too temperamental, so I brought it into the shop for expert(?) treatment.

That set, I think, came nearer to "getting my angora" than any I ever worked on. It seemed that every connection in the thing was bad. I re-soldered every joint that I could see, and yet it refused to work unless pressure was applied at certain points. These points varied from time to time, adding to my confusion. After much hunting, and after using up the supply of language which I reserve for such occasions, I found a terminal, on one of the stators of the gang condenser, which had a generous supply of rosin under it. I carefully cleaned and replaced this, and presto—it still gave the same old trouble! Well, I eventually found the same condition existing in *all* of the terminals connecting to the condenser stators. After I'd cleaned 'em, the set worked perfectly! That was a lesson I've never forgotten; although I still catch myself being careless occasionally.

I had in, some time ago, a brand new A.C. set, of a very popular make, which had stopped working shortly after the dealer had installed it for a demonstration. (Did this ever happen to *you*, Mr. Dealer?) Of course this dealer was very anxious to get it working immediately, and stood over me while I was testing it, asking if this or that might not be wrong, and making many valuable suggestions. (Ever have *this* happen, Mr. Service Man?) Well, I found the '45 power tubes lighting only very dimly, and soon traced this condition to a grounded filament line where a sharp projection on a socket had cut through the insulation. This was soon remedied, and the set worked perfectly. The dealer went happily on his way. "A job well done," thought I.

In less than an hour this same dealer came in again, carrying the radio and a high temperature. It had stopped again! (I privately looked at the serial number, to be sure it *was* the same set!) This time I found no voltage on the plate of the detector tube. This trouble was traced to a wire which was *supposed* to be soldered to the plate terminal of the socket, but had never been touched by solder, and had been simply lying against it. I soldered this, and again the set worked perfectly. The dealer again departed grumbling something under his breath about someone's carelessness. I hadn't the least idea whom he meant! I heaved a sigh of relief.

In less than another hour—believe it or not—that same dealer came in, carrying that same radio, and practically frothing at the mouth! "Such a—blank—service department, and such a —blank—fellow trying to run it, and what a fine location it would be for a real service shop," and much more. I gently agreed with him, and started taking the bottom off the chassis once more. This time it was a case of "poking"; the set could be made to start or stop by a slight

(Continued on page 619)

A Tube Sucker

By MORTON W. STERNS

HOW many Service Men have barked their fingers and "mentally said unpleasant things under their breath" when trying to get a tube into a wafer socket at the bottom of a shield which fits the tube closely and is practically as high as the tube? Now (after letting the roar die down) you all know the fun of removing a type '50 tube from a Sparton 89A, some Stromberg-Carlsons, and many other sets.

Well, to make it very easy and save lots of time and patience, you should buy a little item usually sold in the 5- and 10-cent store. This is a paper clip and flexible rubber vacuum-cup or "sucker," the kind that sticks on glass or other smooth surfaces. The trick is to remove the paper clip and, with the screw, fasten a handle of wood or bakelite to give you a good grip. Press the rubber cup against the top of the tube you wish to remove and, presto! it comes out fastened to the handle as shown in Fig. 1.

MORTON W. STERNS,
139-17 Jamaica Ave., Jamaica, N. Y.

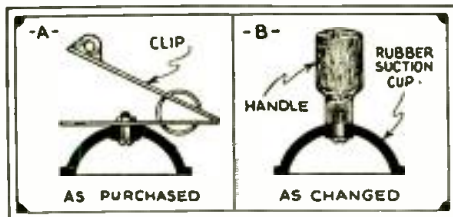

Fig. 1
At the left is shown the vacuum-cup before being dismantled; to the right, the same item after changing.

RADIO SERVICE

(Continued from page 618)

jar. At last I struck a "C" bias resistor that was making a poor contact with its case ground, by reason of an almost imperceptible amount of enamel that had not been scraped off at the factory before bolting fast said resistor. Yet a socket test showed the proper amount of C bias!

Of course, this was an unusual case, and might never happen again. One might think I should have found all this trouble the first time the set was in, but each time I had followed my usual custom of jarring and shaking the chassis while listening for possible further trouble, and anyway, who would ever dream of more than one thing being wrong with a new set of standard make? It must have been the first set to go through the factory early on a Monday morning (you know what I mean). Well, the dealer sold it, after all, so everybody was fairly happy in the end.

And so it goes. There is nothing new or startling in this article; possibly nothing that will be of any help to anyone. But I pass it on for what it may be worth (that is, if the editors are kind enough to have it printed!). Anyway, what I intended to say, before I got completely off the track, was that it pays to look for the simple troubles first; it often saves time—and tempers!

The I R C Formula to Greater PROFITS!

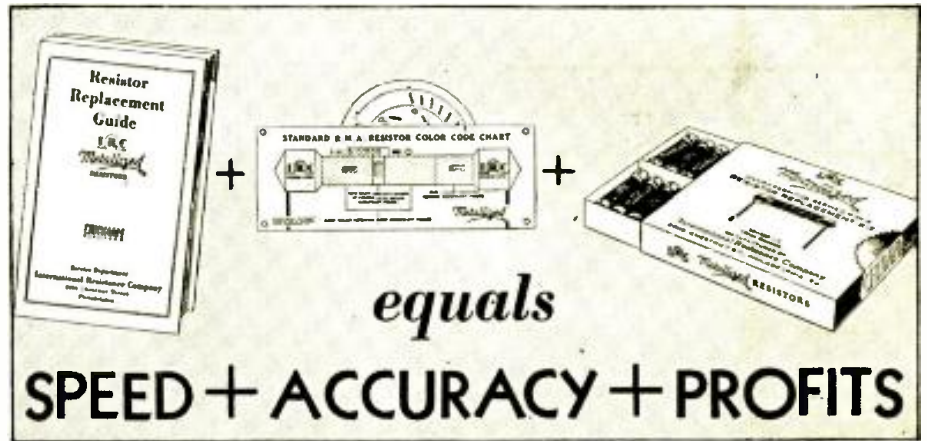

The I. R. C. Resistor Replacement Guide — tells you whether the set has a defective resistor.

The I. R. C. Color Code Chart—gives the resistance value of each defective unit.

The I. R. C. Certified Kit—contains the resistance value you need to repair the receiver.

Mail the coupon and get this Kit with the complete I. R. C. Formula shown above.

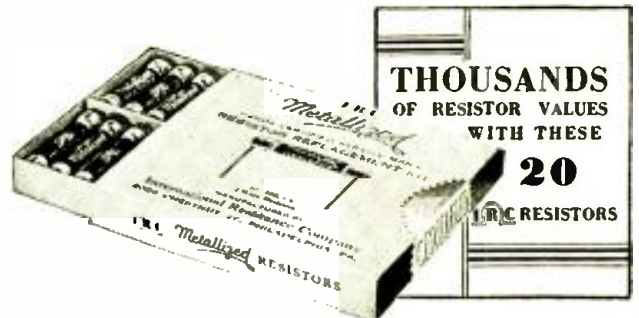

Metallized Resistors

INTERNATIONAL RESISTANCE COMPANY
Philadelphia Toronto

INTERNATIONAL RESISTANCE CO., 2006 Chestnut St., Phila., Pa.

O-4

Gentlemen:

I enclose () check () money order for \$3.50, for which please see that I receive Certified Kit of Metallized Resistors which entitles me to Resistor Guide and Color Code Chart. Free.

Name

Address

City..... State.....

Radio Service Men!

FREE COLOR CHART

Gives R.M.A. standard "color signature" for every resistor value in a flash! Heavy celluloid, 4" by 1". Every service man needs one.

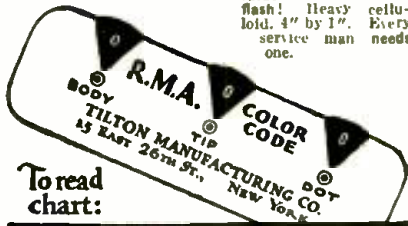

EX-STAT "SIX-KIT"

Six EX-STAT resistors in values you need most list \$1.80

with 25c color-chart Free —a \$2.05 value for 96c

Well-informed service men use more EX-STAT resistors daily. Because EX-STATS are identical with "original-equipment" in most quality sets. Guaranteed, precision resistors you can trust! Now 40% less than 1931 prices. Introductory "Six-Kit" brings exact six values used most... six resistors you're sure to need... in vest-pocket package with chart FREE. Take NO risk. Read coupon clip before offer expires.



Six resistors in "most-used" values: 2,000, 10,000, 25,000, 50,000, 100,000 and 500,000 ohms.

ACT NOW OFFER ENDS APRIL 10

Tilton Manufacturing Company (INC.)
15 East 26th Street, New York, N. Y.
Send "Six-Kit" of EX-STAT resistors, postage prepaid. Include color-chart FREE. I enclose dollar bill. You agree to refund full price if I return kit within 5 days.
Name.....
Address.....
City..... State.....

TESTERS

(Continued from page 611)

Speedy Servicing

In order that the reader may visualize the speed and flexibility of analyses with this tester, a typical analysis on a radio receiver is described. The radio is inoperative with a set of tubes known to be normal.

Beginning with the antenna stage, it is observed that the plate current of each R.F. and of the detector stage is found to be normal, and it is not deemed necessary to read any of the voltages, as normal plate-current indications usually warrant the assumption that the applied potentials are correct. However, it is found that there is an indication of "no plate current" in the first-audio stage.

Now, referring to the Diagonometer instruction booklet, it is observed that the most general causes of "no plate current" are: (1), open grid-bias resistor in cathode- (or filament-) to-ground circuit; (2), shorted plate bypass condenser; or (3), open plate-circuit.

With the Diagonometer, the continuity resistance of all of these circuits can be measured without removing the analyzing plug from the socket, by turning the radio off, and switching the "Multi-Meter" for the ohmmeter connections. Test probes now are connected to the ohmmeter pin jacks, and with one of the test probes touched to the chassis, the other is touched to the cathode contact of the unoccupied "Analyzing" socket of the Diagonometer. The "Multi-Meter" indication of the bias resistance is correct, let us say, so the first possible cause of "no plate current" is eliminated.

The test probe is removed from the cathode terminal of the socket and touched to the plate terminal. The "Multi-Meter" indicates "0" ohms, suggesting a shorted plate bypass condenser.

If the "Multi-Meter" had indicated "Inf." (infinity), the other test probe should have been removed from the chassis to one of the filament terminals of the rectifier socket to determine whether or not the plate circuit were open.

The instruction booklet describes all of the useful functions of the Diagonometer, and includes schematic circuits of all of its testing functions, so that the user may easily familiarize himself with the electrical construction of the circuits. (Two of these illustrations accompany this discussion.)

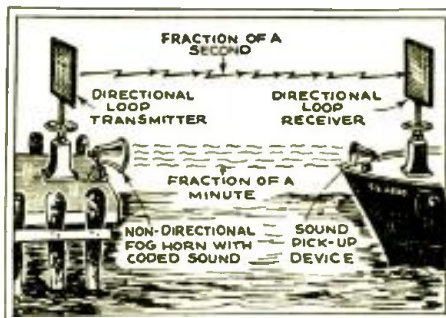

The transmission of standard signals is followed by a similar sound signal. By determining the difference in time between the reception of both and dividing by 5, the distance of the radio beacon is found.

Bring Your Set Analyzer Up To Date with the New ALDEN Latch Lock Analyzer Plug and these New Kits

The new analyzer plug is five prong. It holds the adapter locked to the end of the plug until released by pressing a latch. Thus the adapter is not left stuck in some inaccessible socket of the set you are testing.



- Price of the 905L Analyzer with screen grid contact \$3.00
- 905LC with 5 foot six wire cable 5.00
- 9054DS Four prong base adapter with control locking stud 1.00

Supplied with kits that give you—new adapters with new contacts—new conveniences



THE ESSENTIAL KIT K1

Plug and Adapters for all the usual sets. Adapters separate \$11.35
Adapters in kit with case
Special Price 10.00



THE PROFESSIONAL KIT K2

Meets the demand of the professional serviceman.

Adapters bought separately \$20.15
Adapters in kit with case
Special Price 18.00

The Laboratory 100% DeLuxe Kit K3

Everything the most exacting serviceman or laboratory can wish.

Be sure to send for a description of this kit and price sheets of adapters for all purposes



ALDEN MFG. CO., Dept. R
BROCKTON, MASSACHUSETTS

If you are interested in

|| Servicing Electric Refrigerators

write for full details about the OFFICIAL REFRIGERATION SERVICE MANUAL.

GERNSBACK PUBLICATIONS, INC.

98 Park Place
New York, N. Y.

SOMETHING FOR THE DX FAN

By C. H. W. NASON

FROM Germany comes word of a novel arrangement which permits the tuning-in of distant stations from directly under the antenna of a local broadcaster. To the writer—ever thrilled at the report of new distance records—the rumor was of sufficient importance to invite his investigation.

This device is not a new version of the wavetramp of other days—that is, not an acceptor or rejector circuit in the normal sense—nor is it an additional stage of R.F. amplification, although it does include a tube in its circuit arrangement. It is not

grams without interference from local transmitters. This same prize had been offered for several years past; but the contenders had never presented anything to warrant the award. This year comes a German amateur, Theodor Eckert, with a device of such excellence that not only did it receive the promised financial prize, but it was awarded the silver medal of Heinrich Hertz Institute—which has not had a recipient in the past three years. Without the device a German commercial receiver of normal characteristics could not receive signals even fifty to 100 meters in wavelength away from the Berlin transmitter, the antenna of which could be seen from the testing point.

Upon connecting the Eckert device between the antenna and the receiver, it was found that the interference disappeared entirely; and a distant station but 9 kilocycles from the frequency of the Berlin transmitter could be tuned in without difficulty.

The fact that the tuning of the rejector circuit is quite sharp points to the correctness of this guess.

The variable condensers C1 and C2 have .00035 mf. capacities. The inductances for the rejector are wound on 2¼-inch tubing. L3 and L4 are tapped coils with switches which vary the number of turns from 6 to 25, taps being brought out at the sixth, twelfth and eighteenth turns. Wound on the same tube as L3 is L1, which has 65 turns of No. 22 S.C.C. wire.

A similar coil of 65 turns is wound on the same form as L4. The coupling between L1 and L3 and between L2 and L4 is in no way critical, and separation of the windings by about half an inch should be about correct. L5 and L6 are coils of about 20 turns on the same tube coupled by about one half-inch.

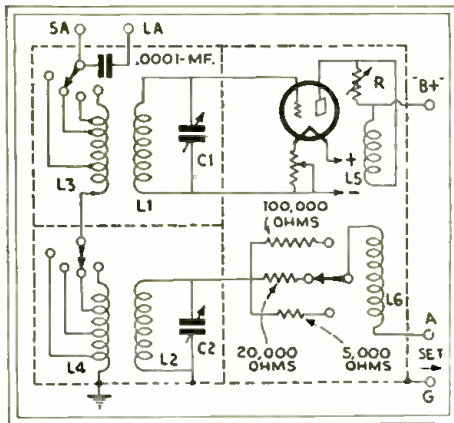

Schematic diagram of the very interesting wave-trap invented by a German radio engineer.

recommended for use where interference of a type curable by other means is involved; but only for those who are really interested in obtaining distant reception, from points adjacent to local broadcasters.

During the course of the Seventh German Radio Exposition last summer the German Broadcasting Company offered a cash prize for a device which could be used with an ordinary receiver to receive distant pro-

THE O. R. S. M. A.

(Continued from page 601)

therefore, are in need of distinctive stationery. For the benefit of these men, letterheads and envelopes have been prepared. The cost of such stationery is very low and is intended to meet the pocketbooks of Service Men, not bankers. Stickers, as illustrated, and a lapel pin may also be obtained. These are supplied to members at cost, since the organization does not operate at a profit.

Advantages

Members of the O.R.S.M.A., through the cooperation of its sponsors, RADIO-CRAFT and GRUNSBACH PUBLICATIONS, Inc., have the privilege of consulting with the Information Bureaus of these organizations regarding any technical questions which may arise during the course of servicing receivers. With the affiliation that the sponsors have with radio-receiver manufacturers, cooperation between the Service Man and the manufacturer is effected to a far greater extent than would be possible if an individual contacted the manufacturer alone.

In view of the care that is exercised in enrolling members, manufacturers, dealers, and service organizations seek the Employment Bureau of the O.R.S.M.A. for men who are qualified to fill positions with their firms. These are readily supplied from the Association's list of members who have made high grades in the examination.

Service Men who are interested in their profession and who are desirous of knowing more about this "live-wire" organization should communicate with the headquarters at 58 Park Place, N. Y. C.

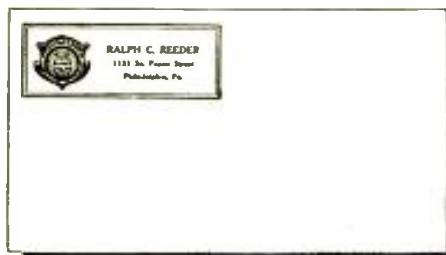

An O.R.S.M.A. envelope.

LOOK INTO RADIO



Scene in our own broadcast studio control room

and the training you get at



FACE your problems frankly. Are you perfectly satisfied with the advances you have made in the past few years? Is your future secure? You cannot hope to succeed without knowledge. That is specially true of radio.

To give men radio knowledge is the sole purpose of America's oldest radio school... RCA Institutes... founded almost a quarter century ago. Here, in four resident schools... New York, Boston, Philadelphia and Chicago... are given elementary or advanced courses in practical radio. The equipment is unsurpassed. Each instructor is an expert in his field.

Then, for those who cannot attend the resident schools, RCA Institutes has extension courses. You may study at home, yet with every advantage, for we furnish special home laboratory equipment with many courses.

RCA Institutes is associated with the largest research laboratory in the radio industry. Courses keep pace with each new development. In spite, however, of the extra advantages you gain at RCA Institutes, the tuition is moderate.

A certificate of graduation from RCA Institutes may be the open door for you into a successful career in radio. The coupon will tell you how to unlock that door. Mark and mail it... before you forget.

A Radio Corporation of America Subsidiary



RCA INSTITUTES, INC.

Dept. RT-4, 75 Varick St., New York.

Please send me your General Catalog. I am checking below the phase of radio in which I am interested.

Microphone Technique, Radio Operating, Broadcast Station or Studio, Talking Pictures, Aviation Radio, Servicing Home Entertainment Equipment, Television

Name

Address

Occupation Age

● Hundreds of Our Students Are Now Engaged In . . .

AVIATION RADIO

Radio is the most fascinating part of Aviation—and Aviation holds the same place in Radio!

So why not train for an interesting, well-paying career in Aviation Radio—just as Lindbergh, Byrd, Eddy and others advise?

Hundreds of our students are now actively engaged in this work. Over 20% of the technical force of Airways Division (U. S. Dept. of Commerce) are enrolled with us. Many other students are connected with American Airways, Boeing Air Transport, Eastern Air Transport, Pan-American Airways, etc.

You Too Can Break Into Aviation the "Radio" Way!

Find out all about our advanced training that fits you for important radio work in Aviation and other fields. Study at home in your spare time—learn as you earn.

Our courses teach you the basic engineering principles of RADIO and TELEVISION. You can never make real progress until you understand these fundamentals. If any branches of RADIO—TELEVISION—AVIATION RADIO—appeal to you—

Just Write for Facts!

CAPITOL RADIO ENGINEERING INSTITUTE, INC.

14th St. and Park Rd., N.W. WASHINGTON, D. C.
Dept. D-12

UNIVERSAL MODEL "BB"
1932 VALUE—NEW DESIGN
LIST PRICE \$25.00

No other 2-Button microphone can give such superlative value for such a low price. Extra large size. Extra rugged construction. Extra excellence of performance. Built especially for voice pick-up, public address work and amateur broadcasts. 24 Kt. Pure Gold Spot Centers. Duralumin Diaphragm. Frequency range to WELL over 4000 cycles. Guaranteed Performance at Rock Bottom Price.

UNIVERSAL MICROPHONE CO., Ltd.
424 Warren Lane, Inglewood, Calif., U. S. A.



Make a PROFIT

Service men make \$90 extra per month installing AMPERITE. Send \$1.62 to Dept. RC-4, for dealers; sample AMPERITE and sales helps.

AMPERITE Corporation
561 BROADWAY, NEW YORK

AMPERITE
Self-Adjusting
LINE VOLTAGE CONTROL



LATEST IN RADIO

(Continued from page 591)

A COMPACT SET ANALYZER

A SERVICE instrument, which combines in one small case all the functions of a tube tester, capacity tester, ohmmeter, continuity tester, and short-checker is the Madsen Set Analyzer illustrated in Fig. G.

Included in the case are the following: Six special test leads; two special connection leads; one pair of continuity-test leads; one adapter; two "C" batteries; one 5-wire cable and plug; one blueprint; and a complete instruction manual.



Fig. G

Front view of the Madsen tube tester.

The meter is of 1,000-ohms-per-volt type. The carrying case measures 8 x 10 x 4 ins. This device is manufactured by the Madsen Instrument Co.

"TRIPLE-TWIN" SET

(Continued from page 593)

- One "Blat the Radio Man" drum-dial aluminum support panel, 4½ ins. long, 2½ ins. wide, with ½-in. edge;
- Two Eby 5-prong wafer-type sockets, for V1 and V2;
- Two Eby 4-prong wafer-type sockets, for V4 and V3;
- Two Eby binding posts, B1 and B2;
- One Bakelite tubing ¼ ins. diameter, 3¾ ins. long for L;
- One Bakelite tubing 1 in. diameter, 1½ ins. long for tickler of L;
- One Utah midget dynamic speaker, 2,500-ohm field, 4,000-ohm primary input transformer, with 4-prong-tube base plug, L.S.;
- One each Speed Type 295, Type 227, Type 280, V1, V2, V3.

COBALT ALLOY FILAMENT

ENGINEERS of the DeForest Radio Company have developed a new filament of cobalt alloy which has a tensile strength when cold that is three times greater than that of the drawn nickel filament previously used for tubes of the 2-volt type; the tensile strength when hot is also much greater than the nickel type.

AERO WORLDWIDE SHORTWAVE RECEIVER
\$6.45

Listen in DIRECT to London, Paris, Berlin, Buenos Aires, and other broadcasting stations throughout the world via short waves. Your amazing receiver cannot tune in these low wave stations. **WORLD-WIDE RECEIVER gets 14 to 150 meters.**



AERO SHORT WAVE CONVERTERS
Convert Your Present Set Into a Short Wave Super-Heterodyne
A. C. MODEL \$12.50—D. C. MODEL \$11.50

AT LAST: The perfect Auto Radio -- ONLY \$20.00
Built by pioneers in the manufacturing of Auto Radio. We guarantee 1000 miles radius of reception. A masterpiece of Radio engineering. Latest model 5 Tube Aero Pentode Auto Radio. Price of set only \$20.00. Set complete with tubes, batteries, dynamic speaker, antenna equipment and noise suppressors. \$39.50.

NEW AERO MIDGET Using the Latest Type Pentode and Multi-Mu Tubes. Price \$16.50. We guarantee coast to coast reception. Wonderful tone quality and selectivity. Full dynamic speaker. Full vision dial. Beautiful walnut cabinet. Tube Set \$16.50, less tubes. Complete set of 5 matched tubes \$4.50 extra.



Send for Complete Catalog
CHAS. HOODWIN CO., 4240 LINCOLN AVENUE Dept. R-15 Chicago, Illinois

CLAROSTAT CONTROL HANDBOOK and CATALOG 1932

FREE!

Write for your copy of the most complete Handbook on every type of a variable resistance—from tiny center taps and volume controls up to heavy motor speed controls. Every Experimenter, Service Man and Engineer should have a copy handy.



CLAROSTAT MFG. CO., Inc.
285 N. 6th St. Brooklyn, N. Y.

DEALERS—AGENTS WANTED

EVERYWHERE, to handle the fastest selling radio attachment on the market today.

THE POLICE LOWWAVE CONVERTER

A new invention that is easily attached to any radio—by means of which anyone can tune in, at any time on local police broadcasting and get such thrilling—exciting—and often sensational—items as headquarters puts on the air for Radio-Police squads. Simple instructions are furnished.

SELLS FOR ONLY \$3.00
Send \$1.79 for sample, no stamps. Or if you wish, send 10c in stamps for C.O.D. order and pay postman the balance of \$1.69.

POLICE LOWWAVE LABORATORIES
1460 Huron St. Dept. 11 Toledo, Ohio

THE NEW MOORE

SUPER-DALITE-R

CALIFORNIA (4 Stations on the Coast)
MEXICO (Also 4 Stations)
CUBA (Easy)

All before 9:30 p.m. in the heart of New York's downtown skyscrapers.

Stations 10 kilocycles from all locals on 200 ft. antenna

Complete Set of Blue Prints—\$1.00

MOORE RADIO COMPANY
76 CORTLANDT ST. NEW YORK, N. Y.

BACK ISSUES
of RADIO-CRAFT can be had at the price of 25c each. Address **RADIO-CRAFT** 98 Park Place New York City

Experimental Equipment Given FREE to Every Student!



Size of Cabinet: Height, 22 1/2", Length, 17 1/2"; Weight 25 lbs.

We give to every student without additional charge his chemical equipment, including fifty pieces of regular standard laboratory apparatus and supplies and forty-two different chemicals and reagents.

Opportunities in Chemistry



Dr. T. O'Connor Sloane

Chemistry offers those who are ambitious and willing to apply themselves conscientiously, the greatest opportunities of any vocation today. Industrial firms of all kinds pay tempting salaries to get the right men. Opportunities abound on every hand. You can study Chemistry under the well-known instructor, T. O'Connor Sloane, A.B., A.M., Ph.D., LL.D.

You Can Learn at Home

Our home study course, written by Dr. Sloane himself, is practical, logical and remarkably simple. It is illustrated by so many experiments that are performed right from the start that anyone can thoroughly understand every lesson. Dr. Sloane will, in addition, give you any individual help you may need in your studies.

Easy Monthly Payments

The tuition is very low, and includes your laboratory outfit—there are no extras to buy with our course. You can pay in small monthly amounts, and we show you how to earn the course of the whole cost as you go along.

CHEMICAL INSTITUTE OF NEW YORK, Inc.

HOME EXTENSION DIVISION
19 Park Place New York, N. Y.

Mail the Coupon NOW!

CHEMICAL INSTITUTE OF NEW YORK.
Home Extension Division
19 Park Place, New York, N. Y.

Please send me at once, without any obligation on my part, your Free Book "Opportunities for Chemists," and full particulars about the Experimental Equipment given to every student. Also please tell me about the latest reduction in tuition price and your easy plan of payment.

NAME

ADDRESS

CITY STATE.....

RC-432

THE "COMET" SET

(Continued from page 595)

rectifier. Its control-grid is automatically biased by a cathode resistor resulting in substantially linear power-detection. In addition to audio frequencies, there is also a large component of intermediate frequency present in its plate circuit. This I.F. component is filtered out by means of a two-stage low-pass filter consisting of two 85-millihenry R.F. chokes and three .00025-mf. bypass condensers. These two filter stages are separately shielded from each other.

The type '47 pentode is used as the output or last stage A.F. amplifier. This tube makes an ideal combination with a '24 type screen-grid tube operated as a linear power-detector. A tone control is provided in the plate circuit of the pentode which enables the listener to modify the response at the higher audio frequencies to suit.

The Station Finder

An important feature of the "Comet" is the "long-wave" oscillator, which can be started and stopped by a switch on the panel. It consists of a '27 type tube and associated circuits and its output is loosely coupled capacitively to the grid of the second-detector. Its circuits are adjusted to oscillate at 465 kc. which is the frequency for which the I.F. amplifier is tuned. Inasmuch as all incoming signals, of whatever frequency, are shifted to 465 kc. by the action of the heterodyne oscillator and the first-detector (or mixer), it will be evident that starting the 465-ke. oscillator will produce an audible beat-note (or whistle), since the signal (coming through the intermediate

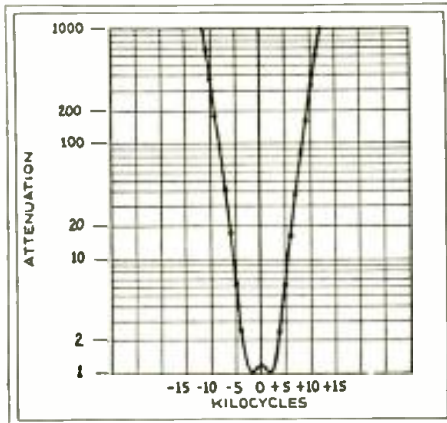

Fig. 5

calculated over-all response curve.

at approximately 465 kc.) and the output of the beat oscillator are both impressed on the grid of the second-detector. Thus the "Comet" is ideal for pure CW reception—the pitch of the beat can be adjusted to suit by means of the left-hand vernier which controls the heterodyne oscillator. Although this feature is primarily intended for CW (code) reception, it is also extremely useful in searching for all signals. It is quite easy to skip right over stations, especially when tuning in the very short waves.

The receiver is substantially "single control." The right-hand vernier controls the wavelength tuning and is most valuable in receiving the longer waves. Under ordinary

(Continued on page 627)

Professional RADIO SERVICE will pay you better profits



Professional servicemen have adopted the accurate, high speed servicing methods made possible by Jewell Service Instruments. Savings in testing time, increased accuracy, and greater customer confidence enable them to not only increase their business, but to make more profit on each job. Jewell Instruments are so reasonable in cost that servicemen cannot afford to be handicapped by inferior test equipment.

Jewell Pattern 444 Set Analyzer

1. Socket current and voltages tests on all types of sets, including those using type 217, 235, and radio frequency pentodes, are provided.
2. Triple range output meter.
3. Triple range resistance-continuity meter with battery compensator.



4. Heavy molded bakelite parts, non-shatterable meter glasses, and all wearing parts easily renewable, are some of the many features that assure long life.

Jewell Pattern 563 Oscillator

1. Three fundamental wave bands of 550 to 1,500 K. C., 125 to 175 K. C., and 160 to 280 K. C. provide for all T. R. F. and superheterodyne sets.
2. Entire instrument, including self-contained batteries, shielded by heavy metal case.
3. Separate output for neutralizing.
4. Priced remarkably low for Jewell quality.

MAIL COUPON TODAY

52 YEARS MAKING INSTRUMENTS

JEWELL

Jewell Electrical Instrument Co.
4 Haynes Ave., Newark, N. J.

Please send me literature on
JEWELL SERVICE INSTRUMENTS
JEWELL TUBE-SELLERS

Name

City State.....

Address

I. F. TRANSFORMER DESIGN

(Continued from page 597)

control on the pre-amplifier end of the receiver will be full on and the gain on the I.F. amplifier cut away down.

If the pre-modulator amplifier is limited to one stage, it will be necessary to increase the gain of the I.F. amplifier if the same level of sensitivity is to be maintained.

Unlike the conditions which exist in T.R.F. amplifiers (where the limitations of the minimum and maximum capacity range of the tuning condenser, plus the unavoidable circuit capacities, define the maximum ratio of the tuning inductance to its tuning capacity), we find that the tuning circuits of I.F. amplifiers are not limited as stated above, and the ratio of L to C can be any ratio desired, within sensible limits.

Inductance Design

Thus, the inductance of the I.F. transformer can be made as large as desired; the limitations being defined by the R.F. resistance and the physical size of the coil and associated shield. As the frequency of the I.F. amplifier is generally lower than the broadcast-band frequencies, the effect of the circuit and coil capacities can be neglected for the moment as any calculation which we shall make will generally assume that the signal is fed into the tuned circuit by induction in the coil itself. In Fig. 6A, we find that the distributed capacity of the coil shunts the tuning condenser and is simply added to the circuit; in Fig. 6B, the signal is in series with the coil.

Calculation of Load Impedance

To obtain the greatest percentage of the "mu" of a vacuum tube, it is necessary that the load in the plate circuit be as large as possible.

The effective impedance of the tuned circuit at resonance (Fig. 7) is equal to

$$Z = \frac{I^2 W^2}{r} = \frac{L}{Cr}$$

where L = the inductance of the coil,
 W = 6.28 times the frequency f,
 r = the series high resistance of the coil,
 C = the capacity necessary for resonance.

It will be noted that the effective impedance increases as the square of the inductance; so, provided we keep the R.F. resist-

ance of the coil low, a large inductance will be superior to a small one.

In such a tuned circuit, the selectivity S will be proportional to

$$S = \frac{WL}{r}$$

and the width of the resonance curve, Fig. 8, at a point where the response is .707 times the value at resonance, is related to the ratio

$$S = \frac{WL}{r} = \frac{fr}{f_2 - f_1}$$

giving another valid reason for using a coil as large as possible. A handy rule to use in the design of such circuits is that

$$\frac{WL}{r}$$

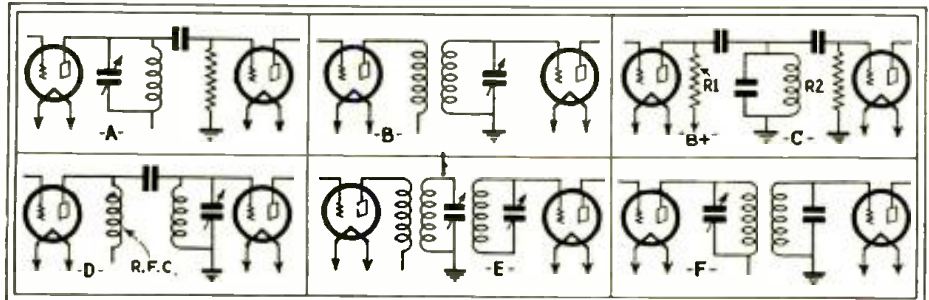

Fig. 10
 At A, B, C, D, E, and F are shown the various methods of coupling I.F. amplifiers.

**RADIO'S
 NEWEST
 BOOK » »**

MODERN VACUUM TUBES

And How They Work

By Robert Hertzberg

THE vacuum tube is one of the most important single elements in radio work of any kind, yet it is probably the least understood of all radio devices. Most radio experimenters and Service Men have only a hazy idea as to how it functions, and because of this lack of knowledge, they cannot realize the greatest enjoyment or profit from their work.

The book contains valuable reference charts and characteristic curves of all the standard tubes and many special ones; detailed "exploded" views of the various types; diagrams of socket and pin connections, etc. These charts alone are worth the price of the book. Slip a copy into your service kit and you will find it useful on almost every job.

MODERN VACUUM TUBES, our newest book in the Radio-Craft Library series will help to make the theory and operation of tubes understandable to everyone. It is written in clear, simple language, and is devoid of the mathematics that confuses the practical man who has neither the time nor the desire to wrestle with complicated formulas and equations. It describes the fundamental electron theory, which is the basis of all vacuum tube action, and goes progressively from the simplest two-element tubes up to the latest pentodes and thyratrons. It will quickly brush away many misunderstandings about radio tube operation that have been bothering you for years.

Mail Coupon Today!

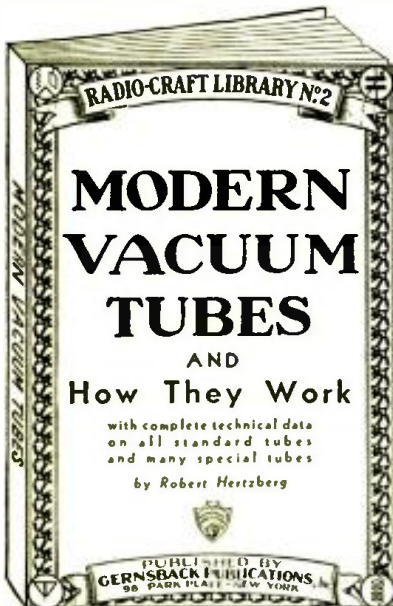

64 Pages—6 x 9 Inches
 Over 50 Illustrations

50c
 the Copy

GERNSBACK PUBLICATIONS, Inc. RC-4
 98 Park Place, New York, N. Y.

I enclose herewith fifty (50) cents (stamps, check or money order, accepted) for which send me a copy of your book "Modern Vacuum Tubes and How They Work."

Name

Address

City State



GREATEST MAGAZINE IN TELEVISION



IMELY developments in radio's latest wonder, Television, are published in every issue of TELEVISION NEWS—Mr. Hugo Gernsback's latest magazine. Rapid advancement in this art today is becoming a repetition of the radio cycle of years ago. Daily broadcasts are becoming more numerous and experimenters are following in quick order in building television sets for experimental purposes. Foresight of its development can be seen by the pioneers of radio—they are equipping themselves now with television experience.

The articles published in TELEVISION NEWS are of primary importance to experimenters—they are simple in construction, understandable and replete with diagrams, photographs and illustrations.

Interesting Articles in the Current Issue

- Light Beam Television.
- New European Television Kits.
- Radio Frequency Operation of Neon Tubes.
- A Simple Lens-Disc Projector.
- Powerful Light Source for Television.
- Digest of Television Patents.
- Television Course.
- Practical Hints on Cathode Ray Scanners.
- Fidelity Tests for Television Systems.
- Pioneer Receiver and Scanner.
- A New System for Television Synchronization.
- and other unusually interesting topics.

SPECIAL OFFER COUPON

TELEVISION NEWS RC-432
98 Park Place, New York, N. Y.

I enclose herewith my remittance of \$1.25, (Canada and foreign \$1.50) check or money order preferred, for which you are to enter my subscription to TELEVISION NEWS for One Year, also send me the last two issues gratis. I understand that the regular subscription rate is \$1.50 and this offer will be void after March 31st. TELEVISION NEWS is published every other month.

NAME
ADDRESS
CITY..... STATE.....

should be less than 250, for if the ratio of the inductive reactance of the coil to the R.F. resistance is greater than 250, there will be marked attenuation of the higher audio frequencies in the detector output.

The condition of resonance is the same, no matter what the frequency may be, and the old L.C. chart is as useful as ever; as it gives the L.C. constants for all frequencies between 1000 and 12 kc., thus taking in all of the frequencies used in I.F. amplifier design.

Design of an I.F. Transformer

Most of the readers will be interested in 175-ke. intermediates, so a design will be developed for this frequency.

Examination of such a chart shows that 176.5 kc. is the nearest frequency to 175 kc. and will be satisfactory for our purpose. The L.C. constant for this frequency is 813 when the inductance and capacity are expressed in centimeters (1000 centimeters equal one microhenry) and microfarads, respectively.

The RADIO-CRAFT readers, who have followed the articles by this author on the calculation of R.F. coils in previous issues, will be familiar with the method involved in determining the values of the inductance and capacity by the process of dividing one known value, either L or C, into the L.C. constant to derive the other.

There are several types of semivariable condensers with capacity ranges running up to 140 mmf., which could be shunted with a good grade of fixed condenser to increase the maximum value of capacity if desired. Earlier, we discussed the added gain to be obtained by the use of a large inductance provided the R.F. losses of the large coil did not affect the resultant amplification and selectivity.

TABLE II.

SPIDERWEB I.F. Coils					
Wire Size	No. of Spokes	No. of Turns	Inside Dim.	Frequency Range	
No. 24 d.o.o.	15	62	1 3/4 in.	1764-500 kc. (170-600 m.)	
No. 20 d.o.o.	17	46	2 in. (no form)	2540-566 kc. (116-529 m.)	
No. 24 d.o.o.	11	80	1 1/2 in.	2830-566 kc. (114-529 m.)	
BASKETWEAVE I.F. Coils					
No. 18 enm. d.o.o.	13	58	2 5/8 in. bet. pug centers	2361-500 kc. (127-600 m.)	
No. 18 d.o.o.	14	60	4 1/8 in. bet. pug centers	2290-560 kc. (131-545 m.)	
No. 24 d.o.o.	15	64	2 1/2 in. bet. pug centers	2064-498 kc. (146-606 m.)	
DIAMONDWEAVE I.F. Coils					
No. 26 d.o.o.	15	57	2 1/8 in.	2040-496 kc. (147-606 m.)	
No. 20 d.o.o.	21	36	2 3/4 in.	2650-694 kc. (113-432 m.)	
No. 24 d.o.o.	15	44	2 3/8 in.	1764-560 kc. (170-536 m.)	

Winding data for three types of coils.

So, for the tuning capacity, let us select a unit with a maximum capacity of 140 mmf. and see just what inductance will be necessary to tune to 176.5 kc. As

$$L = \frac{LC}{C}$$

813
L = $\frac{813}{.000110}$ = 5,800,000 centimeters
and as 1000 centimeters equal one micro-

The Public Approves These Sensational Low-Priced CROSLEY SUPER-HETERODYNES



The Crosley TYNAMITE

The gem of all radio receivers! The attractive cabinet is of fine selected woods, carefully finished and high-lighted. The 4-tube super-heterodyne chassis incorporates pentode output, variable mu, i muge suppression pre-selector, combined volume control and on-off switch, illuminated station selector. Full floating moving coil dynamic speaker is used. Dimensions: 13 1/2" high, 9 3/4" wide, 7 1/2" deep. A low-boy console model, The BONNIBOY, housing the same chassis, sells for \$39.75.



The Crosley LITLFELLA

The walnut veneer front panel of this exquisite receiver is arched with oriental veneer and is supported at the sides with delicately fluted pilasters. This super-heterodyne incorporates five tubes, pentode output, variable mu, continuous (stepless) tone and static control and on-off switch, volume control, illuminated shadow dial with vernier drive and dynamic speaker. Dimensions: 17" high, 13" wide, 8 1/2" deep. The BIG-FELLA, console for \$48.48 and The PLAYTIME, Jr. grandfather clock model for \$79.75 incorporate the same chassis. Details of entire line from your Crosley Distributor.



Montana, Wyoming, Colorado, New Mexico and west, prices slightly higher.

The Crosley Radio Corporation

Powel Crosley, Jr., President
Home of "the Nation's Station"—WLW
CINCINNATI





Readrite

No. 550

OSCILLATOR

Licensed by A. T. & T. Co.

\$18 Net to dealer
\$30 list

\$21 Net to dealer
with output meter

If not at your Jobbers we will ship direct when remittance accompanies order.

A sturdy modulated instrument carefully made. Completely shielded with separate battery compartment. Furnished with 22½-v. and 3-v. batteries and one '30 tube. Direct reading broadcast band (550-1500 kc.) and intermediate band (120-185 kc.). Sharp 2d and 3d harmonics for 260 and 475 kc. Operating instructions attached in case cover with shielded wire leads. Very compact. In leatherette case, 6x11½x5½ in. Weighs but 8 pounds. Built to high standards. Every serviceman should have the No. 550 oscillator to align r.f. gang condensers, locate defective r.f. transformers, adjust i.f. transformers, check oscillator stage and determine sensitivity of a receiver. A necessary instrument. Get yours today. Write for catalog of servicing instruments.

Readrite Meter Works
17 College Ave.
Bluffton, Ohio

Please send all information about Readrite Oscillator and other service instruments.

Name

Address

City..... State.....

Readrite Meter Works

Established 1904

17 College Ave., Bluffton, Ohio

henry, we require an inductance of 5,800 microhenries. Now 5,800 microhenries is considerable inductance to put in a small space, but a good coil can be had by using any of the commonly-known methods of winding, such as diamond weave, duolateral, honeycomb, etc. Most of us do not have the equipment on hand to wind a coil in this manner, so it would be practical for us to increase the size of the tuning condenser to .0005-mf. so that we could reduce the inductance to a lower value. Semivariable condensers of compact size can be obtained in ranges up to .001-mf. and are satisfactory for I.F. circuits. With the new capacity of .0005-mf., we find

$$813 \text{ --- } = 1,626,000 \text{ centimeters,}$$

.0005 or 1,626 microhenries.

By reference to the chart in Fig. 9, we can determine a coil which can be hand wound at home.

By connecting three known or assumed values as per the key, we find that a coil wound on a 2-in. diameter cylinder 3 ins. long, having 120 turns per in. for a length of 2 ins., or a total of 240 turns of No. 34 S.S.C. wire, will have an inductance of 1,625 millihenries. A coil made up in this size can be placed in a shield, providing that the distance from the coil to the shield is at least 1½ ins. all around. Under these conditions, it will be necessary to add 20% to the inductance of the coil to compensate for the loss due to the effect of the shield.

A wire table is given in Table II for the convenience of the reader and takes in all of the commonly-used sizes and coverings.

The impedance of the combination is equal to

$$Z = \frac{L^2 W^2}{r} = \frac{L}{Cr}$$

$$= \frac{.0016}{.000,000,000,5} \times \frac{1}{32} = 100,000 \text{ ohms.}$$

The resistance r is assumed to have a value of 32 ohms.

Selecting the Circuit

With the solution of the effective impedance of the tuned circuit at the resonant frequency, we can select the circuit in which the coil and condenser are to be used. Fig. 10 gives several possible variations, all incorporating the tuned circuit with its impedance of 100,000 ohms at 175 kc. A in Fig. 10 is the old tuned-plate type of R.F. circuit and, if used with tubes whose internal impedances (Rp) are less than 100,000 ohms, will not tune sharply. B in Fig. 10 has a primary design to match the tube Rp if possible and has a definite voltage gain when used with low-impedance tubes. The circuit in C, Fig. 10, is not used as the losses due to the shunting effect of R1 and R2 reduce the effective load in the plate and will not be selective. In D, Fig. 10, the plate circuit is loaded by the choke R.F.C. and the signal is passed to the tuned circuit through the coupling capacity. A circuit which is used in A.K. superheterodynes is shown at E, Fig. 10. Here two tuned circuits are used to increase selectivity.

Most I.F. amplifiers today have tuned input and output circuits as shown in F,

(Continued on page 633)

SAYS: "IT'S A RADIO BIBLE"

Dear Sir:

Your second edition Radio Encyclopedia was received in good form. I take this opportunity to praise your work and I will openly say that for anyone who contemplates Radio experiments, or at present is doing any kind of Radio work, this Encyclopedia should be his "Radio Bible." No one in this line should be without it. I have your first edition Encyclopedia. It is worth anyone's time to study it. I learned valuable information from it.

But this second edition is really a "knockout." I especially admire the flexible binding, and the loose-leaf form of its contents.

I promptly advised several of my friends what a wonderful Encyclopedia this one is, and I am sure they will place their order for one each.

JAMES P. WARE,
St. Louis, Mo.

What the New Second Edition Radio Encyclopedia Gives You

It gives you an explanation of every word used in radio. These explanations—or, rather, definitions—are not brief outline information like those of an ordinary dictionary, but they give in fullest detail, and at considerable length, the meaning and application of every word, phrase, general and special term used in the science of radio. They are written in plain, everyday English, easily understood by anyone.

Practically every definition in the book is illustrated by drawings, photographs, diagrams, or charts. All you need to do is to look up as you would in a dictionary, the word or phrase about which you are seeking information. Furthermore, each page is key-indexed, for greater convenience and speed in locating any definition. All the Subject-Matter is Arranged in Alphabetical Order.

This greatly enlarged Second Edition Radio Encyclopedia is an absolute necessity to everyone interested in Radio. It answers all radio questions, increases your knowledge and saves your time. It covers every known radio problem, and is a goldmine of practical information for every radio man.

- 2,201 RADIO DEFINITIONS
- 1,253 TECHNICAL ILLUSTRATIONS
- 34 TABLES AND CHARTS
- 24 PAGES OF APPENDIX
- Red Morocco-Keratol Flexible Binding
- Printed on strong ledger paper, Loose-Leaf Arrangement

352 pages
9 x 12 inches
Weight 3 lbs.

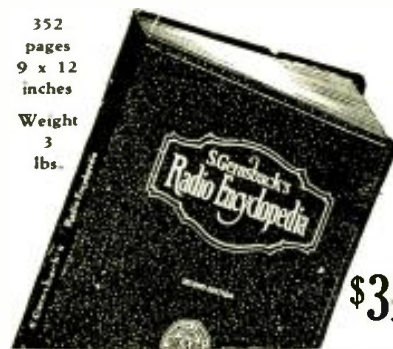

\$3.98

S. GERNSBACK CORPORATION,
98 Park Place, New York, N. Y.

Send me one copy of the new Second Edition S. Gernsback Radio Encyclopedia. I enclose herewith \$3.98, check or money order preferred. (Foreign and Canada, add 50c extra for postage.) Money refunded in full if not satisfactory.

Name

Address

City..... State.....

A New and Useful Book for Service Men-

HERE is the latest book, and one of the most important which we have ever published. It is the first book that explains COMPLETELY the operation of analyzers, tube checkers, oscillators, etc., from a thoroughly practical standpoint. The book is intended for Service Men of all classes, whether Junior grade or expert. Everyone will find a tremendous amount of live "meat" in its pages. Nothing has been left to your own ingenuity; everything is complete.

- The contents:
- CHAPTER 1: Introduction:**
 The Problems of the Service Man
 General Description of Modern Receivers
 The Need for a Radio Set Analyzer
 What to Expect from an Analyzer
- CHAPTER 2: The Analyzer:**
 The Fundamental Requirements of an Analyzer
 The Switches or Push Buttons
 The Ammeter
 Multiscale Ammeters
 The Shunt and Its Calibration
 The D.C. Voltmeter
 The Multiscale D.C. Voltmeter
 The Multiplier and Its Calibration
 The A.C. Voltmeter
 The Design of a Simple Analyzer
- CHAPTER 3: Trouble Shooting with the Analyzer:**
 Classification of Trouble—
 (1) External to the receiver
 (2) In the receiver proper
 (a) Mechanical troubles
 (b) Electrical troubles.
 Detailed Analysis of Electrical Troubles—
 (1) Tube Testing
 (2) Localizing trouble
 (a) By past experience
 (b) By actual test of circuit
 (3) Interpretation of analyzer readings
 (4) Tube charts (use of)
 (5) Circuit diagrams (use of)
 (6) Testing the power unit
 (7) The use of the analyzer in testing individual units
 Additional Features and Uses of the Analyzer—
 (1) As a modulated R.F. oscillator
 (2) As a means of linking up R.F. and I.F. amplifiers
 (3) As an output meter
 Care and Maintenance of Analyzers
 Conclusion and Brief Summary

CHAPTER 4

Detailed descriptions, photographs, and circuit diagrams of commercial set analyzers.

Published by RADIO-CRAFT It has included in it all worth-while information available to the radio servicing profession.

50c

The Copy

MAIL THE COUPON TODAY!

RADIO LIBRARY N°1

RADIO SET ANALYZERS

AND
How to Use Them

with full instructions and descriptions of set analyzers, tube checkers, oscillators

by L. V. GERNSBACK PUBLICATIONS, Inc.

96RC Park Pl., New York, N. Y.

I enclose herewith fifty (50) cents, for which send me a copy of your book, "Radio Set Analyzers and How to Use Them."

Name

Address

City and State

A BAND SELECTOR

(Continued from page 600)

ferred through the coupler L1-L2 to the input of the filter, and through this partly to the grid of V1 and partly to that of V2, to which it is directly connected. The energy applied to V1 is amplified and fed back through the plate coil L2 into the filter, from which it is again applied to V2. While the regenerative action increases the signal strength, I have found the circuit quite stable, especially with the use of the potentiometer R in the grid return circuit.

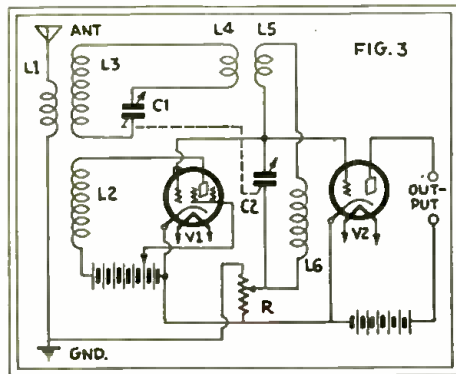

Fig. 3 Simplified circuit of the band selector.

A signal, of other frequency than that to which the band-pass filter is tuned, is applied only to the plate of V1, and is therefore practically ineffective on the output. In Fig. 3, the tuned circuits L3-C1 and L6-C2 are coupled inductively through the coils L4 and L5; the aerial coil L1 is coupled directly to L3; and the capacity C2, which is part of the filter, is also the reactance which couples V1 to V2. The general action of the circuit is the same. The potentiometer R, as before, controls the regeneration; and in addition it provides bias for the grids of V1 and V2. It is obvious that there are many possible modifications, of the coupling methods shown here, which will produce a similar result.

* See "Band Selectors and Their Application," on page 546, RADIO-CRAFT for March, 1931, for a discussion of the design of filters and appropriate circuit values.

THE "COMET" SET

(Continued from page 623)

operating conditions, most stations can be tuned in with the main control alone irrespective of vernier settings. When a station is heard, it can then be tuned in accurately by means of the verniers. When a signal has been tuned in this manner, other stations a few degrees above or below it may be tuned in solely by the use of the main control.

In tuning the set, it has been found that stations on the 15- to 20-meter band are heard best during the daylight, or from daybreak to 2:00 P.M. From noon to 10:00 P.M., stations in Europe operating on from 20 to 33 meters can be heard. Stations to the west on 20 to 33 meters are heard best from 10:00 P.M. to daybreak.



how Centralab fixed Resistors are made » » »

Send today for the "BAPTISM OF FIRE" a handsomely illustrated booklet telling how CENTRALAB FIXED RESISTORS are made. It is free . . . use the coupon. Tells graphically just why CENTRALAB resistors are different and better.

new low prices on Centralab Volume Controls

Radio dealers and service-men will welcome the news that CENTRALAB CONTROLS are now available at radically reduced prices. Now it is possible to use CENTRALAB Replacement units at prices no higher than so called "just as good controls." Send for the new CENTRALAB VOLUME CONTROL GUIDE.



930 E. Keefe Ave., Milwaukee, Wis.

Mail the Coupon Today

CENTRAL RADIO LABORATORIES
930 E. Keefe Ave. Milwaukee Wis.
Please send me your Free Booklet "A Baptism of Fire"
Am enclosing 25c for your VOLUME CONTROL GUIDE

Name

Address

City

Province

Radio Craft

SHORT CUTS IN RADIO SERVICE

(Continued from page 605)

angular block in the carrying case will have to be chipped out in order to allow clearance for the leaves of the switch.) To bring the sixth wire into the analyzer, use the new "Na-Aid" analyzer plug handle with the locking feature, Fig. 3B.

Now for the reversing switch. A Hart and Hegeman D.P.D.T. toggle switch is just the thing. However, the writer made one from several old jacks as shown in Fig. 3C and mounted it between the "4-8 volt" and "MA" toggle switches. The "VM Return" switch is an ordinary S.P.D.T. toggle switch, and is placed in the upper right-hand corner of the panel; the entire triangular block in the carrying case must be chipped out.

The resistors used to obtain the additional voltage ranges are of the pigtail type, and of 2-watt capacity. The 52,000-ohm resistor of the "control-grid 60-volt" scale can be eliminated by using the 60-volt resistor connected to the "60-volt" binding post. If this is done, it will be necessary to set the bipolar switch at "control-grid 60" and to reverse the meter, when using the "60-volt" binding post for tests.

After these changes are made, place a 4½-volt "C" battery in the rear compartment of the carrying case as shown in Fig. 3D, and connect a short lead from the positive post of the battery to the "8-volt" binding post of the A.C. meter. By connecting one of the test prods to the nega-

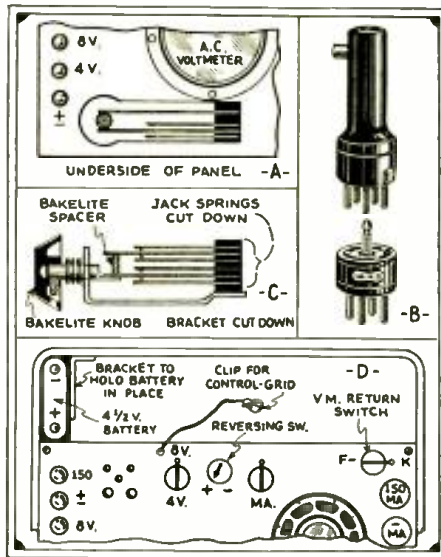

Fig. 3
Detail views of the author's tester.

tive side of the battery, and the other to the "plus-minus" post on the A.C. meter, a low-ohmic continuity tester results; by removing the test prod from the "plus-minus" post and connecting it to the "MA" binding post and setting the switch dial to read "A volts," a 1000-ohms-per-volt continuity tester is obtained. In the latter

position, the following ohmmeter readings, with a 4½-volt battery, are secured:

Unknown Resistance	Reading on "8-volt" scale
0	4.50
500	4.23
1000	4.00
1500	3.79
2000	3.60
2500	3.42
3000	3.27
3500	3.13
4000	3.00
4500	2.88
5000	2.77
6000	2.57
7000	2.40
8000	2.25
9000	2.11
10000	2.00
15000	1.56
20000	1.28
30000	0.94
40000	0.75
50000	0.62
75000	0.46
100000	0.33

Also, the 150-volt A.C. meter can be used as a "microfarad meter" by connecting one side of the 110-volt line direct to the meter, and connecting various condensers in series with the other side of the line, and noting the readings. Many other combinations of readings are possible for special cases.

THREE NEW 50c BOOKS



FORMULAS AND RECIPES For the PRACTICAL MAN

CONTENTS

1. Adhesives: Glues, Cements, Gums, Mucilages, Lubricants
2. Cleansing: Stain Removers, Bleaches, Cleaning Fluids
3. Metal Craft: Coloring, Oxidizing, Plating, Repairing, Welding, Polishes, Alloys, Solders
4. Paints: Colors, Stains, Varnishes, Enamels, Luminous Paint, Washable Paint, Paint-Removing, Waterproofing, Fireproofing
5. Glass-Working: Cutting, Drilling, Boring, Bending, Blowing, Etching, Engraving, Finishing, Silvers, etc.
6. Wood-Craft: Fillers, Fireproofing, Acid-proofing, Waterproofing, Furniture Polishes
7. Inks: Eradicators, Ink Stain Removers; Svin-pasthelic, Indelible, Hectograph
8. Photography: Developers, Emulsions, Fixers, Sensitizing, Toning, Printing, Photographic Paper
9. Antidotes for Poisons, Remedies for Burns and Scalds, Disinfectants, First-Aid in Accidents, Home Remedies
10. Preparation, Manipulation, Handling, Mixing, Emulsifying; Use of Hydrometer, Use of Thermometer; Tables of Weights and Measures, Decimal System, Useful Tables.

FROM the table of contents, it will be seen that the book contains only such material as is constantly needed and can be practically applied by the man who is doing or making things.

Every formula has been selected with a view to its usefulness to the experimenter and practical technical man.

Not only that—this book is intended to serve directly for the use of the man who wishes to work out desirable preparations for practical home manufacture, as a means to earning spare-time money.

It is well known, in the case of innumerable preparations that have become household standbys and whose production now runs into millions of dollars of profit—and if the truth were known, this would be found to be the origin of nearly all such successful enterprises—that the biggest manufacturers, who have built up tremendous factories making all those things which you use in your own home, shop, and business, started on the road to success with just such a small beginning as you, perhaps have been dreaming about.

This book will be useful also in helping you to save money by showing you how to make in your own home at a fraction of their usual cost the hundred and one preparations which you now buy ready-made for use in your home or business.

This book has been compiled by S. Gernsback, a well-known author of practical instructional manuals in various scientific fields. You will find it a real help and an instrument for self advancement. It will serve you as a money-saver and a money-maker!



FUNDAMENTAL PRINCIPLES OF RADIO Radio Simply Explained—Its Origin, Nature and Functions

- ### CONTENTS
- (Chapter I—Fundamentals of Radio: Electricity, Resistance, Batteries, The Magnetic Circuit, The Magnetic Field, Inductance, Condensers, A.C. Circuits, Propagation of Radio Waves; Chapter II—The Simple Radio Set, Single, Two, and Three - Circuit Tuners, The Battery Set, Vacuum Tubes, Electric Sets, Loud Speakers; Chapter III—Diagrams, How to Read Them, Chapter IV—Amateur and Broadcast Stations, Talking Pictures, Television.)

THIS BOOK is intended as a handy fundamental aid for "checking up" and systematizing your knowledge of radio, no matter what stage of the art you have thus far mastered by study or experience.

It is intended for those who may have had to get their first working knowledge of radio through experience in a haphazard fashion and now want to get a more solid grounding in its principles and theory.

It is intended for the practical man, the technician who wants to get a practical comprehensive knowledge of the principles underlying the HOW and WHY of Radio.

The book has been prepared with special consideration for the young members of the profession; and one of the main objects has been to state in plain English the few important elementary principles which the authors of most books on radio envelop in such a haze of technical mystery as to keep their explanations beyond the understanding of the ordinary man.

There is no more mystery about radio in the mind of the reader after he has read this book!

The author, being a former instructor in radio, knows how to go about explaining in simple language, the origin and nature of radio; he leads his reader through clear description and practical analogies, step by step, until he understands the working of the most complicated circuit.

You will find in Mr. Martin's book a really intelligible discussion of a lot of subjects in radio, for which you have never before been able to find an elementary explanation in such easy-to-grasp and understandable terms.

Even if you think that you know a very great deal about radio, you should get this book, even if only to see in what a charmingly easy way Mr. Martin has dealt with a difficult and abstract subject.

THIS MANUAL has been written especially for the man who wishes to acquire a working knowledge of the elementary principles of mathematics for his own every-day use. To provide a complete treatment, the author starts from the beginning of the subject, explaining the first principles of arithmetic in simple, clearly understandable language, and from these, takes the reader by easy steps through all the rules and processes of arithmetical calculation.

A good technician is not always a good mathematician, but the art of computation by figures is easy to acquire, if you are guided by some one who knows how to direct your way and make it easy.

That is the object of this book, Mr. Shainmark, who is an instructor in practical sciences, knows how to explain things in plain English, and his one purpose in this book is to make clear, in terms of daily application, the important basic principles of mathematics which everyone ought to know, whether he be a working man, a merchant, or a professional man.

Special attention is devoted in this book to showing the man who is employed in industry or in technical work, how to apply the working rules of mathematics in his profession or business.

All our books are of uniform size 6 1/2 in. containing 64 pages printed on strong paper with gilt colored covers.

PRESS GUILD INC., 16 Murray St., New York City. RC-4

Enclosed find \$..... for which mail me postpaid the following books:

- No. 1
 - No. 2
 - No. 3
- 50c each, Postpaid, all three for \$1.25.

Name
Address
City and State

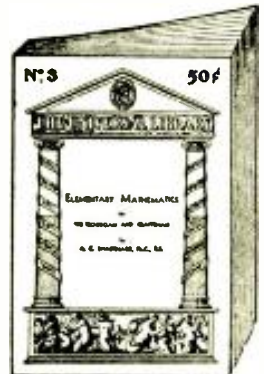

ELEMENTARY MATHEMATICS For the Technician and Craftsman

CONTENTS

- I—Arithmetic: Addition, Multiplication, Subtraction, Division, How to Use Decimals; II—Fractions, Percentages, Ratio and Proportions; III Powers and Roots; IV—The Metric System; V—How to Measure Surfaces and Volumes; VI—Mathematics for the Manual and Technical Craftsman; VII—Special Mathematics for the Radio Technician; VIII—Commercial Calculations, Short-cut Arithmetic, Interest Calculation, Discounts; IX—Weights and Measures; X—Useful Tables.

EXPERIMENTS

(Continued from page 609)

secured by using a coupling coil, either tuned or untuned.

The reception obtained is, of course, due to the alternate heating and cooling of the filament in accordance with the modulated carrier wave. Such being the case, the lower notes are naturally accentuated. The finer the wire, the stronger should be the effect, and this suggests the '99 tube as being preferable. Several of these were tried, but the power available was too great and they were soon burned out, not having the protection of the vacuum.

An "Electrostatic" Receiver

Another simple method of reception and a much more efficient one, is to employ the electrostatic principle. To demonstrate this, a pound-size tobacco can and a lead weight about 3/8-in. thick and 2 ins. in diameter, are required. The weight may be made by filling the lid of a small tin can somewhat overful, and then dressing the surface down until it is smooth and flat. This weight is to be mounted along the axis of the center of the bottom of the can, but insulated therefrom and with a small air space between, as shown in Fig. 3.

A simple way is to fasten the weight to a piece of thin hardwood, arranged with an adjusting screw at one end, and a piece of heavy tin at the other. Place the weight in position with a piece of card between it and the can, and then solder the tin to the edge of the can. This will insure parallelism of the two surfaces.

When the can was connected as in Fig. 4, sparks, or rather a brush discharge, passed between the can and the weight, making it necessary to add a thin sheet of mica to the bottom of the can. The resulting music is, of course, rather tinny, but can be heard all over the room. With a different

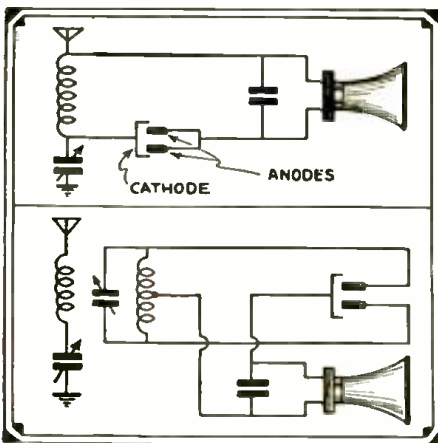

Fig. 8, above. A simple "gas-rectifier" set.

Fig. 9, below. An improved circuit of Fig. 8.

wavelength or with reduced power, it would probably be advisable to use a coupling coil, as in Fig. 5. In this case, the coil should have enough turns to make tuning possible by merely adjusting the distance between the weight and the can.

A "Cigarette Box" Receiver

Another way of demonstrating electrostatic reception, though not so effective, is

THE NEW EMC SIMPLICITY TEST PROBE

PRECISION MADE

For Servicemen, Dealers and Experimenters; a fast, efficient vest-pocket size testing device. The Simplicity Test Probe locates open or shorted by-pass and filter condensers, burned-out resistors and wiring, breaks in tuning coil windings and shorts in variable tuning condensers; also checks presence of filament or heater voltage and correctness of tuning coil polarity.

It tests continuity of all low resistance windings and resistors, the following is one of the many uses which make this Probe worth many times its price.

To test open-circuited by-pass condensers, remove lamp from probe end, attach test probe clip to chassis, turn on set and touch high-voltage terminals of all by-pass condensers. When terminals of faulty condenser is touched set will perform normally.



THE SERVICEMAN'S FRIEND

The EMC Simplicity Probe is made of a polished red and black dielectric material neatly engraved in gold. It is exceptionally attractive and professional; a real quality product. Guaranteed and comes complete with standard lamp and full instructions for use.

JUST OUT—Special EMC Current-limiting adapter for simplicity test probe and Neon bulb. Permits test of AC and DC voltages from 110 to 400 volts. Price of adapter, \$.50; Neon bulb, \$.55; both for \$1.00; outside of U. S. A. \$1.30. Net price of probe outside of U. S. A., \$2.00, at Boston. Send money orders or cash for adapter, bulb or probe direct.

\$1.50 NET

Immediate Delivery

ELECTRICAL MANUFACTURING CORP.
10 HIGH STREET, BOSTON, MASS.

to use one of those flat, thin tin boxes that cigarettes come in, placing a sheet of paper on top, and then a piece of tin foil on top of this. Scatter a half-dozen small screws, nuts or other small weights on the foil so as to keep it fairly flat (Fig. 6). The foil and the box may now be connected up as suggested in the case of the tobacco can, and when the ear is held within a foot or so, speech or music may be plainly heard.

A Batteryless Tube Receiver

Excellent loud-speaker reception may be had by using a phone unit and a long horn, and employing a '71A tube, but absolutely no "A" or "B" supply, the entire energy coming through the air! The connections are shown in Fig. 7. The coil used is 3 3/4-ins. in diameter and 2 3/4 ins. long, wound with No. 22 D.C.C. wire. It will be noted that the filament is connected directly in the oscillating circuit, and lights up to normal with the high-frequency radio current when the coupling with the aerial circuit is quite loose. This means very accurate tuning. The grid is not used, as the tube functions merely as a rectifier. Sometimes better results are had when it is connected to the plate. The return connection from the speaker to the coil should be made to the most effective point. This point is not critical and may be provided for by taking out several taps when the coil is being wound. With this hook-up, so much power was available that a high-resistance carbon rheostat was placed in the plate circuit, and a .025-mf. condenser across the speaker to bring out the lower notes. It may be stated that the '71A tube is quite remarkable, as good loud-speaker reception can be had even when the filament shows no sign of redness.

A Raytheon Receiver

Reception that was uncomfortably loud was secured by using a Raytheon rectifying tube (no "A" or "B" supply whatever) in the manner illustrated in Figs. 8 and 9.

(Continued on page 630)

SERVICEMEN!

FREE

New LYNCH RESISTOR Replacement MANUAL

With purchase of 10 LYNCH Metallized Resistors, or Manual alone may be bought for \$1.00.

Covers more than 200 RECEIVERS

New Low List Prices

1 Watt 30c; 2 Watt 40c; 3 Watt 50c.



LYNCH RESISTORS

1, 2, and 3 Watts

Metallized Precision Wire Wound

Send order today for Manual, new reduced price catalog and R.M.A. Color Code Card. LYNCH MFG. CO., Inc., 1775RC Broadway, N. Y. C.

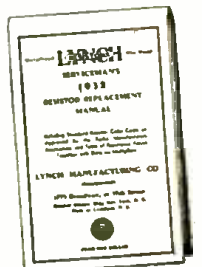

RADIO DEALERS
RADIO SERVICEMEN

NEW
Radio Handbook

CONTAINING:

Technical Information
Volume Control Guide.
Transformer and Condenser Guide.
Radio Replacement Parts Catalog.

Sent postpaid anywhere for only

25 Cents

Hard to Get Parts—We have them. Send us your Repair work for estimate.

Grant Radio Laboratories

6521-C South Halsted Street, Chicago, Ill.

ARCO Tubes are best ---and they cost much less!

Presented here are the largest variety of tubes in the world—tubes that are guaranteed to be first grade quality, replaceable within 30 days. The prices are extremely low when you consider the long service that these tubes will give you. Such an amazing tube sale has never been conducted. Many tubes for special purposes are listed here which cannot be gotten elsewhere. A complete line of tubes include: PENTODES, SCREEN GRID, VARIABLE MUX, POWER AMPLIFIERS, DETECTORS, PHOTOELECTRIC CELLS, TELEVISION, RECTIFIER AND CHARGER BULBS. We either have it or will make it for you.

COMPLETE STOCK ALWAYS READY FOR IMMEDIATE SHIPMENT

Order from this page and note the following terms: No order accepted for less than \$5.00. It is not necessary to send the full amount of cash with the order as long as your order is accompanied by 20% of the value. Shipment will go forward to you by express or parcel post C. O. D. All prices are F. O. B. Factory, Newark.

UX-201A	\$.30	UX-232	.60	Special radio frequency 201A—a	.60
UX-226	.30	UX-233	.60	super-sensitive 201A	.60
UX-227	.30	UY-236	.60	Special audio frequency 201A—a	.60
UX-171A	.30	UY-237	.60	super-sensitive 201A	.60
UX-171	.30	UY-238	.60	Special 171 AC 1/2 amp. extra	.60
UX-240	.40	WD-11	.60	coated filament—good for electric	.60
UX-120	.40	WD-12	.60	sets	.60
UX-199	.40	UY-235	.85	T-14 (201A High Mu) high emis-	.60
UY-199	.40	UY-247	.85	sion	.60
UX-112	.40	UY-551	.85	Switch tube, 201A or 112 or 171	.60
UX-112A	.40	UX-210	1.10	double life	.60
UX-200A	.40	UX-222	1.10	Adapter tube 226, 227, 171A, to	.60
UX-224	.40	UX-250	1.10	convert bat. sets to AC, each	.60
UX-245	.40	Ballast tube to prevent tubes	1.10	UY-227A—AC amplifier or detector,	.60
UX-230	.60	from blowing out	1.10	same as 227 (but quick heater)	.60
UX-231	.60	Special detector tube 200A—a	.60	UY-224A—AC screen grid amplifier,	.60
		super-sensitive detector	.60	same as 224 (but quick heater)	.60

RECTIFIER AND CHARGER BULBS

125 MH. rectifying tube (H. H.) (Raytheon Type)	\$1.40
6/10 amp. trickle charger bulb (Tungar Type)	2.00
2 amp. old and new type charger bulbs (list \$4.00) (Tungar Type)	2.00
5 and 6 amp. charger bulbs (list \$8.00) (Tungar Type)	3.75
15 amp. charger bulbs (Tungar Type)	7.50
UX-280—Used as a full-wave rectifier for high emulsion	.40
UX-281—Half-wave rectifier	1.10
Rectifying Tube especially designed for use with Freshman Master "H"	
Eliminators UV brass base, limited quantity	.30
UX-866—Mercury Vapor Half-Wave Rectifier (Heavy Duty)	3.75
UX-280—Mercury Vapor Full-Wave Rectifier or UX588	1.40

DISCOUNTS: 100 Tubes and Over 10%
500 Tubes and Over 10% and 10%

ARCO TUBE COMPANY, 38-40 Park Place, Newark, N. J.

SHORT WAVE Converter
SUBMARINER \$12.50
Acrocycle Oscillator \$17.50
SEND FOR FREE CIRCULAR
J.-M.-P. MANUFACTURING CO., Inc.
3353 Fond du Lac Ave. Milwaukee, Wis.

The TRANSMITTER UNIT
with 100 Uses
SKINDERVIKEN MICROPHONE BUT-TON—Powerful Speech and Phonograph Amplifier—Detectophone, etc., etc. One unit 95¢—two, \$1.75, with 12-page booklet of experiments. Sent C. O. D. in U. S. foreign—cash with order. PRESS GUILD, INC., 16 Murray St., Dept. D-432, New York, N. Y.



CRAFTSMAN'S PAGE

(Continued from page 608)



nouncement, is plagued with the haunting air of a number he cannot identify by name, no matter how good a memory for music he may have? He struggles along for days worrying himself and his friends to learn the name of the tune.

My idea, therefore, is to build an apparatus (based, of course, upon radio construction) which will have a microphone, and the individual may approach, whistle, sing, or otherwise render the tune into the "mike" and—presto—the machine announces the name of the piece!

If the above can be worked out, it will be a blessing to us all.

ARTHUR BERND,
Box 104, Macon, Ga.

(Evidently our correspondent is not aware that one of the biggest attractions at the last Radio Show held in New York City was a robot which spoke a few words, lighted at the eyes, and moved forward and handed an award of vacuum tubes to the person in the crowd who whistled a few key bars from the correct one of the Broadway hit songs. Of a surety, truth is stranger than fiction, and fact is but an echo of fancy. See RADIO-CRAFT for July, 1931.

However, judging by the design complexity, and difficulties in maintenance encountered in this model, the more pretentious construction proposed by Mr. Bernd, is more likely to result in a "nut inventor," than invention, should anyone endeavor to tackle this problem anywhere other than in the movies.—Technical Editor.)

EXPERIMENTS

(Continued from page 629)

The latter method will probably prove preferable where difficulty is had in securing a sufficiently high voltage. By providing the secondary coil with plenty of turns, a step-up effect is secured.

A Raytheon tube used in this manner supplies enough direct current to run a small high-speed motor. The field consists of a heavy permanent magnet, with the poles about 1 in. apart and 3/4-in. wide. The small armature has a two-part commutator, and is wound with No. 40 wire on a wooden core. An iron core would have been vastly more efficient, but the experiment did not warrant the work that would have been necessary to make one so accurately balanced that the powerful magnet would not have held it to one side or the other.

A Raytheon, or similar gas-filled tube, is a useful adjunct in these experiments. When held by the glass bulb, and the proper prong on the base is held to the aerial circuit or coupled tuned circuit at a high-potential point, it lights up with the pretty pink glow of helium. If a sensitive headset is being worn at the time (the cord dangling unconnected in the air), strange to say, reception will occur. If one is standing near the lead-in and the aerial coil, holding a chunk of good galena in one hand and one of the phone tips in the other, reception will be had if the other phone tip is allowed to touch a sensitive spot on the galena.

Mind Your P's and Q's

Purchase
Parts for
Profit

Quality
Quality
Quality

POLYMET PRODUCTS—if used exclusively—enable radio service-men to make guaranteed repairs,—a certain way to build up both reputation and a steady business. Good workmanship and good parts will hasten your success. Follow radio's leaders and standardize on POLYMET condensers, resistors, chokes, transformers and other essentials.

New Lower Prices
Mail the Coupon

POLYMET MFG. CORP.
834 E. 134th St., N. Y. C.

Send me your new and valuable 1932 Radio Parts Catalog.

Name

Address

City

State

Mark Proper Square

- JOBBER CUSTOM SET BUILDER
 SERVICE MAN DEALER



POLYMET MFG. CORP.

World's Largest Manufacturer of
Radio Essentials

834 E. 134th Street New York City

SOUND RECORDING

(Continued from page 611)

the turntable shaft. The motor drives the disk on which are mounted the steel springs, and these springs in turn drive the cam. Any irregularity in the speed of the motor is instantly dampened out in the springs and not transmitted to the table.

Figure 7 shows the simplest and cheapest form of filtering. The motor shaft has mounted on it a small rubber pulley which runs on the inside of the rim of the turntable. There is a definite ratio between the motor pulley and turntable rim so that proper speed reduction is obtained. The rubber pulley is the filter, and tests have proven it to be very effective. The beauty of this drive is that it is absolutely quiet because it contains no worms or worm gears which are usually the source of a great deal of noise.

Cutting Heads

In a previous article, the theory of cutting heads was gone into quite thoroughly and what was pointed out then will be repeated here briefly—namely, that present-day pickups, while they are suitable for experimental recordings, are not efficient enough for quality work. They must be properly dampened so that their characteristics simulate the characteristics of a commercial recording head. This is something that should not be attempted in the home or shop, but should be left for the laboratory. The importance of using a cutting head that has a good response curve cannot be too strongly stressed, for it has the same relation to the whole system as a loud-speaker has to a radio set. The most efficient receiver in the world sounds very "sour" if its output is fed into a poor speaker.

Instantaneous recording has progressed so rapidly in the past few years that the mere fact that it works is not enough to justify satisfaction. Now, the problem of efficiency has come up, and there is no doubt that every serious experimenter has given this some deep thought and wondered if it would ever be possible to make records as good as the commercial ones.

While this article has gone into some of the ways and means of obtaining faithful recordings, lack of space has prevented a thorough and comprehensive analysis of all the problems. As has been stated before, the future of any new art is in the hands of the experimenters, so let us have your comments on what you have discovered. Address all letters and inquiries to the Sound-Recording Department.

SERVICE FORUM

(Continued from page 604)

the following: "We regret to inform you that these service sheets are supplied only to authorized Atwater Kent dealers and therefore we cannot fulfill your request."

On the face of the above, I think Jack Levine surely must have received his A.K. manual from some other source, and not from the Atwater Kent factory.

WALTER A. GLENNY,

382 Washington Ave., Belleville, N. J.

Royal Short-Wave Receiver

SCREEN-GRID—POWER PENTODE
WORLD-WIDE RECEPTION GUARANTEED



ROYAL Model RP
List Price \$25

A NEW Super-Sensitive Short Wave Receiver especially designed for the reception of broadcasting and code from all parts of the world, airplane reports, police transmissions, ship conversations, etc. Guaranteed to give better results than others selling for higher prices.

Sturdily constructed on a heavy metal chassis and enclosed in a neat crackle finished cabinet it presents an attractive, efficient appearance. A full vision dial and a combination regeneration—volume control (with automatic switch) makes tuning remarkably easy. This set tunes from 14 to 200 meters (550 meter coil 75c extra). A special "Ham" model is available with the amateur bands widely spread. (State your choice). The use of a 1/4-232 screen-grid detector and a 233 power pentode amplifier gives extreme sensitivity and tremendous volume.

Send your order (with a small deposit) NOW for immediate delivery and enjoy A NEW THRILL!

DEALERS! Write for our proposition

DISTRIBUTED BY

SPECIAL PRICE \$14.95
Set of Tubes...\$2.20
Batteries...5.45

HARRISON RADIO CO., Dept. R4 189 Franklin St. New York City

Special Introductory Offer

We need immediately 100,000 users—agents the country over to tell their friends of the improvement of using Pentode Tubes in place of 245's, particularly in sets using 245 push-pull.

There is a tremendous improvement in depth of tone and set sensitivity. The improved amplification brings in weak signals.

The Pentode Tube is inserted in Na-aid 954KPC adapter and the adapter put in the socket in the set. No change in wiring.

Money Back—Adapters list at \$1.00—But for the first 100 people that order from any town we will send two adapters for \$1.00 or two pentode tubes and two adapters postpaid for \$3.00.

Try them—if you are not pleased return within 5 days and your money will be instantly refunded. As this offer is limited, order today.

ALDEN MANUFACTURING COMPANY
Dept. R Brockton, Massachusetts



LISTENERS OFFICIAL RADIO LOG

An accurate up-to-date call book. Regular and short-wave broadcasting stations of the world—U. S. map and short wave World map—Special illustrated short-wave features—contains just the information your customers demand—good for advertising or resale.

Jobbers, Dealers, Mrs. Service Men—write today on letterhead for sample and quantity prices.

ALL AMERICAN SERVICE

5707 N. Clark St. CHICAGO, ILL.



BACK ISSUES OF RADIO-CRAFT can still be had at the regular price of 25c per copy. If you are in need of any issues to complete your file, send us your remittance in check, stamps or money order, together with the months and year, and we shall forward your copies to you immediately. Address: RADIO-CRAFT, 98 Park Place, New York, N. Y.



The WHEEL WITHIN the WHEEL...

INSIDE your radio business is ANOTHER business—A SERVICE BUSINESS—the "Wheel Within the Wheel."

And that SERVICE wheel is closer to the hub, that supports all, than many radio men realize.

Our observation shows that service men who conduct their Service Departments as a business which should show a PROFIT, never fail to make a profit out of it.

A SURE way to make a PROFIT from your Service Department is to use ELECTRAD high-quality replacement parts. They save both time and money.

Mail the coupon for money-making service helps.

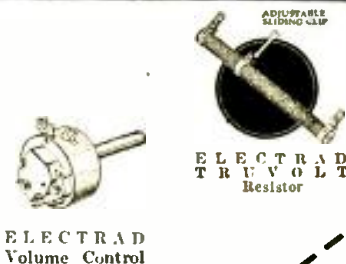

ELECTRAD Volume Control

175 Varick St., New York, N. Y.
ELECTRAD
LHC.

Send me literature on Electrad Replacement Resistors and Voltage Controls.
Name _____ Address _____
ELECTRAD, INC., Dept. RC-A, 175 Varick Street, New York, N. Y.

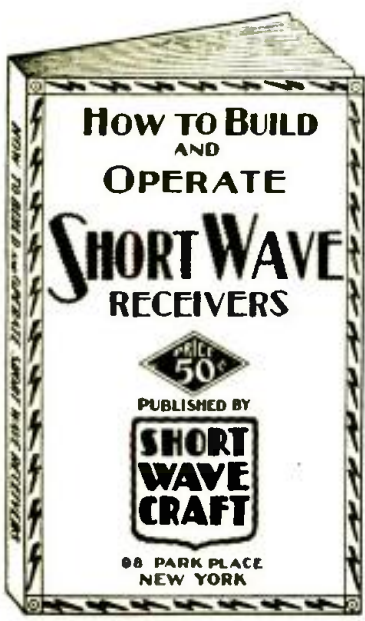

Nothing Like It!

THE greatest book of its kind ever published. **HOW TO BUILD AND OPERATE SHORT WAVE RECEIVERS** is the best and most up-to-date book on the subject ever put between two covers.

The book has been edited and prepared by the editors of **SHORT WAVE CRAFT**, and contains a wealth of material on the building and operation, not only of typical short wave receivers, but short wave converters as well.

Dozens of short wave sets will be found in this book, which contains hundreds of illustrations; actual photographs of sets built, hook-ups and diagrams galore.

WE SAY—AND REPEAT IT—THAT NOTHING LIKE THIS HAS EVER BEEN PUBLISHED BEFORE.

The book comes with a heavy colored cover, and is printed throughout on fine-class paper. No expense has been spared to make this the outstanding volume of its kind. The book measures 7½ x 10 inches.

This book is sold only at such a ridiculously low price because it is our aim to put this valuable work into the hands of 50,000 short wave enthusiasts during the first few months of 1932.

Published by the publishers of **SHORT WAVE CRAFT** magazine. This alone will be your guarantee that it is a really worthwhile publication.

We know that if you are at all interested in short waves you will not wish to do without this book. It is a most important and timely new radio publication.

NOT SOLD ON NEWSSTANDS
Mail Coupon At Left!

SHORT WAVE CRAFT RC-4
96-98 Park Place, New York City.

I enclose herewith fifty (50c) cents for which please send me a copy of your new book **HOW TO BUILD AND OPERATE SHORT WAVE RECEIVERS**. (Send money order, check, cash, or new U. S. Stamp. Register letter if it contains currency or stamps.)

Name

Address

City and State

AN S.-W. RECEIVER

(Continued from page 613)

signals, amateur phones from all over, and all of the principal American, European and Asiatic short-wave broadcasters, all without any fading.

Coil Data

A table showing construction details of the short-wave coils is shown in Fig. 6. For the broadcast band, the primary coil consists of 450 turns of No. 34 D.C.C. wire, bunch wound .5-in. in length on a form 2 ins. in diameter. The secondary consists of 83 turns of No. 24 enameled wire on the same tube which is 3¾ ins. long.

Parts List

- One 2-gang variable condenser, 365 mmf. max., C1, C2;
- One oscillator trimmer condenser, C3;
- One trimmer condenser, 25 mmf., C4;
- One variable Midget condenser, 200 mmf., C5;
- Six trimmer condensers, 125 mmf., C6, C7, C8, C9, C10, C11;
- Five .1-mf. condensers, C12, C15, C17, C21, C31;
- Two .001-mf. condensers, C13, C27;
- One 150-mf. condenser, C14;
- Two 500-mmf. condensers, C16, C19;
- One 100-mmf. condenser, C18;
- Four 1-mf. condensers, C20, C21, C25, C26;
- Two .5-mf. condensers, C22, C23;
- One .15-mf. condenser, C28;
- One .025-mf. condenser, C29;
- One .006-mf. condenser, C30;
- One 8-mf. dry electrolytic condenser, C32;
- Two 4-mf. dry electrolytic condensers, C33, C34;
- Two 400-ohm resistors (wire wound), R1, R6;
- One 220-ohm resistor, R14;
- Two 3,500-ohm resistors, (wire wound) R2, (1-watt carbon) R5;
- Three 300,000-ohm resistors (1-watt carbon), R3, R7, R18;
- One 60,000-ohm resistor (1-watt carbon), R4;
- One 6,500-ohm resistor (3-watt carbon), R8;
- Two 10,000-ohm resistors, (2-watt carbon) R9, (1-watt carbon) R16;
- Three 100,000-ohm resistors, (1-watt carbon) R10, R17, (Volume Control) R11;
- One .5-meg. tapered variable resistor, R12;
- One 25,000-ohm resistor (1-watt carbon), R13;
- One 1-meg. resistor (1-watt carbon), R15.

WAVE BAND IN METERS	SECONDARY COIL			PICKUP COIL (CLOSE WOUND)		FORM O.D.	SPACE BETWEEN WINDINGS
	NO OF TURNS	TURNS PER INCH	SIZE OF WIRE	NO OF TURNS	SIZE OF WIRE		
16-35	6 ¾	10 ⅔	17 ENAM	10 ½	№ 36 D. S. C.	⅞"	1/16"
35-65	16 ¾	12 ¾	19 ENAM	12 ½	№ 36 D. S. C.	⅞"	1/16"
65-100	23 ¾	16 ¾	21 ENAM	12 ½	№ 36 D. S. C.	1 ¼"	1/16"
100-200	48 ¾	32	27 ENAM	18 ½	№ 36 D. S. C.	1 ¼"	1/16"

Fig. 6

Coil data of the S.M. 727 receiver.

This interesting receiver will, no doubt, attain world-wide attention. The very ingenious oscillator and harmonic-generator scheme is sure to attract the attention of all engineers who appreciate the efficiency and simplicity of this very novel idea.

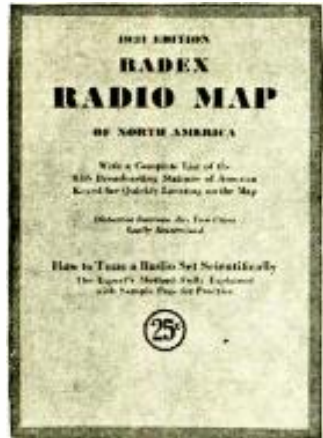

A RADIO MAP OF NORTH AMERICA

Nearly five times the size of this page. Shows location of every broadcasting station in Canada, United States, Mexico, Central America and West Indies. Scale for quickly computing distances. Time zones accurately shown. All stations listed geographically with key for instant location on map.

Explains scientific method of tuning with examples for practice. *Adopted as official map Newark News DX Club as basis for awarding*

medals for distance. At newsstands everywhere or postpaid on receipt of

THE RADEX PRESS **25c**
5005 Euclid Ave. Cleveland, Ohio

\$5,000 WILL BE PAID TO ANYONE WHO PROVES THAT THIS IS not the actual photo of myself showing my superb physique and how the Ross System has increased my own height to 6 ft. 3 3/4 inches. Hundreds of Testimonials. Clients up to 45 years old gain from 1 to 6 inches in a few weeks!



First in 1907 First To-day

No Appliances—No Drugs—No Dieting. ROSS SYSTEM NEVER FAILS. For Ten Dollars Complete. Convince Testimony and Particulars 5 cent stamp. Allow time for return mails across the Atlantic. **G. MALCOLM ROSS, Height Specialist, Scarborough, England, (P. O. Box 15).**

Read about our new plan for buying the 1931 and 1932 **OFFICIAL RADIO SERVICE MANUALS**. Full details concerning this will be found on page 580. Turn to it NOW.

ALUMINUM BOX SHIELDS

Genuine "ALCOA" stock, silverdip finish, 5 x 9 x 6, \$1.89—14 x 6 x 6, 3.85. 10 x 6 x 7 Monitor size \$3.25. 5 x 5 x 5 Coll shield (like picture on right) \$1.00.



Any Size to Order.
Skinderviken Button, 95c.
"BUDDY" TEST PRODS.



Always sharp pointed, using phonograph needles, 4-ft. wires, spade or phone tips. Colored nipples identify each lead, \$1.50 pair.

We specialize in radio parts exclusively—parts furnished for any kit in any magazine. Carrying Cases for Set Testers, Analyzers, Portable Sets

BLAN, THE RADIO MAN, Inc.

89 Cortlandt St. Dept. RC-432 New York, N. Y.

NEW 1932 HAND-LAPEL MIKES

- No. 306—Single Button \$5.00
 - No. 501—Single Button 10.00
 - No. 503—Two Button 15.00
- and 15 other types for every occasion.

Also Direct Manufacturers of Amplifiers, Horn Units, Trumpets and All P. A. Accessories

Send for Catalogue RC Now
MILES REPRODUCER CO.
26 East 22nd St., N. Y. C.



TUBE CHECKER



as shown or "short" tester can be built with our 1 1/2, 2, 2 1/2, 3, 5, 6, 7 1/2 volt 25 watt transformer. Full instructions for building tube checker. Tests ALL modern new tubes also "short element" tester without switches. Trans. \$2.25, shipping wt. 5 lbs. Add P.P.

L & L ELECTRIC CO.
336 Madison Ave., Memphis, Tenn.

Classified Advertisements

Advertisements in this section are inserted at the cost of ten cents per word for each insertion—name, initial and address each count as one word. Cash should accompany all classified advertisements unless placed by a recognized advertising agency. No less than ten words are accepted. Advertising for the May 1932 issue should be received not later than March 7th.

CHEMISTRY

BECOME TRAINED CHEMIST. Thousands of opportunities—fascinating career. Learn at home. Complete experimental laboratory outfit given. Write for big free book. (Chemical Institute, 19 Park Place, Dept. RC, New York.)

INVENTORS

PATENT YOUR INVENTION: Send for FREE book. "How to Obtain a Patent," and "Record of Invention" blank. Consult us about how to protect your ideas. Victor J. Evans & Co., 620D Victor Bldg., Washington, D. C.

RADIO

TRANSFORMERS (Radio Power) rewind, special types made to order. Supreme Radio Laboratory, 16 Fulton Avenue, Rochester, N. Y.

SERVICE MEN, ATTENTION—Speakers re-wound, magnetized, repaired, \$2.00 to \$2.75. Complete Power Pack Service—Transformers re-wound, condenser blocks repaired, resistors duplicated. Guaranteed. Clark Brothers Radio Co., Albia, Iowa.

SET OWNERS, separate those interfering stations on your tuning dial. Easy to install. 50c postpaid. Noel, 1502 Pittston, Scranton, Penna.

SERVICE MEN and shops. Transformers (power) re-wound, also special types made. Supreme Radio Laboratory, 16 Fulton Ave., Rochester, N. Y.

HERE'S YOUR CHANCE—new Hickok Analyzer with case. Guaranteed perfect. Fifty Dollars. R. D. Wills, Allport, Penna.

RADIO INSTRUCTION

LEARN Radio, television and talking pictures in Canada. Day, evening and home study classes. Free scholarship and trip to Toronto, all expenses paid. Booklet on request. Radio College of Canada, 310 Yonge St., Toronto.

I.F. TRANSFORMERS

(Continued from page 626)

Fig. 10. Both coils and condensers are tuned to the same frequency and the mutual inductance between the coils is held to a low value. In some cases, the circuits are detuned, thus causing a flattening out of the peak of the resonance curve shown in Fig. 8.

The following table contains practical values for the turns ratio of the windings used in circuit B, Fig. 10. These ratios are not the maximum but are good workable ones giving excellent gain, good selectivity and stability.

Type	Tube	Ratio
(1)	'01A, '27, '30, '37	3.5 to 1
(2)	'12A, '26	3.8 to 1
(3)	'99	2 to 1
(4)	'35, '21, '32, '22, '36	1.4 to 1

I.F. IN KC	SEC TURNS	TYPE OF WINDG SIZE	NO OF LAYERS	TUNING COND. IN MF	PRIMARY TURNS TUBE NO.			
					1	2	3	4
45	630	MS2ENAM.	7	.001-	180	165	315	450
75	400	MS30 "	5	.001-	114	105	200	285
100	400	MS30 "	5	.00065-	114	105	200	285
150	213	MS28 "	3	.001-	60	56	106	152
200	213	MS28 "	3	.0005-	60	56	56	152
250	213	MS28 "	3	.00025-	60	106	56	152
300	112	MS28 "	1	.001-	32	29	56	80
500	112	MS28 "	1	.00035-	32	29	56	80

Transformer data for circuit B, Fig. 10.

The standard form used for winding any of the above is 3 ins. long and 2 ins. in diameter.

This article is based on the reference material gathered by the author over an extended period of time and he hopes that it will prove as useful to others as it has to himself in the past.

RADIO KINKS

(Continued from page 614)

tion of the device. The relay may be so adjusted as to operate either to turn the controlled circuits on or off with the application of light.

This same device may be used so that automobile head-lamps control the opening of the garage door—so that persons intercepting a beam which normally keeps the relay closed will cause it to open and thus sound an alarm. No long-winded description is necessary, however, for a thousand uses for the device will immediately suggest themselves.

The parts are as follows: R1, 350 ohms, 5 watts; R2, 3500 ohms, Electrad potentiometer; R3, 1- to 5-megohm grid leak; P.E.C., a caesium type gas-filled photoelectric cell; Relay, Yaxley 10,000-ohm relay or device of similar sensitivity.

OPERATING NOTES

(Continued from page 603)

The hum would appear and then disappear. It was finally traced to an open 3-ohm center-tap resistor located a few inches away from the first intermediate-frequency socket on the under side of the chassis. The open was most likely caused by the operation of the set without the several heater tubes in their proper respective sockets.

STUDY RADIO RADIO SERVICING COURSE

by Alfred A. Ghirardi and Bertram M. Freed

Contributing Editor, Radio Craft Servicing Department.

\$1.50

Postpaid in the U. S. 192 Pages, Over 100 illustrations.



RADIO PHYSICS COURSE

Nobody in Radio can afford to be without these two great books. Written by two of Radio's foremost authorities, they cover every phase of the subject up to the present moment. These are financially profitable books to own! They will give you a complete radio education—in your spare time at home!

By Alfred A. Ghirardi The Radio Physics Course now running in Radio News—complete in one book!

\$3.50

Postpaid in the U.S. 392 Pages, Over 500 illustrations.

MAIL THIS COUPON AT ONCE!

RADIO TECH. PUB. CO., Dept. R.C. 22 West 21st St., New York City.

Enclosed find check, cash or money order for copies of Radio Physics Course at \$3.50 each, and copies of the Radio Servicing Course at \$1.50 each. Check here for FREE circular.....

Name
Address
City State.....

RADOLEK SERVICE MEN SEND for THIS BOOK FREE! YOU NEED IT

1932 PRICE GUIDE

Radio Supplies—Tubes—Sets
Every item you require in your business is in this book, from the finest high grade mike to the smallest screw.

GUARANTEED QUALITY GOODS
Prices Lowest Ever Quoted
Fresh new dependable Merchandise at Bargain Prices!

Leading Manufacturers Lines Complete
Send For Your Copy Now!
SAMPLE BUYS FROM THIS BOOK

-  \$14.65
 -  \$1.98
 -  69c
- and Three Thousand Other Bargains

HEADQUARTERS for SERVICE MEN'S SUPPLIES

601 W. RANDOLPH ST. CHICAGO, ILL.

Pin This Coupon to Your Letterhead or Card
Radolek Co., 104 Canal Station Chicago, Ill.
Please send me without obligation your Service Man's Supply Book.
Name
Address
City State

RADIO-CRAFT

READERS' BUREAU

A NEW FREE SERVICE

1. **LOW RANGE FUSES.** Technical data on "Littelfuses," low-current fuses designed to protect meters, tube filaments and other sensitive radio and electrical devices from disastrous overloads. Contains some interesting oscillograms, recorded at Northwestern University, which show the quick action of these fuses. *Littelfuse Laboratories.*

2. **FACTS ON SOLDERING.** A handsomely prepared booklet that explains the why's and wherefore's of soldering with great clarity and in fine detail. The chapter on the purpose and action of fluxes is particularly instructive and can be read with profit by anyone who does not understand this important phase of the soldering art. The right and wrong methods of soldering are described and illustrated, and many practical hints given. *Kester Solder Company.*

3. **TYPE 551 VARIABLE-MU TUBE.** An excellent treatise on the characteristics and applications of the '51 tube. Clearly written in technical but understandable language. Complete operating curves and circuit data are given. *Arcturus Radio Tube Company.*

4. **TECHNICAL DATA ON CECO RADIO TUBES.** A folder containing thirteen loose-leaf engineering bulletins and a chart of average characteristics of the Ceco line of tubes. The bulletins cover the following types in detail: '80, '50, '24, '27, '01A, '45, '35, '36 series, '47, '81, '66, '10, '33. Very useful for reference purposes. *Ceco Manufacturing Company, Inc.*

5. **CLAROSTAT CONTROL HANDBOOK.** A large 32-page book containing detailed specifications of volume controls, attenuators, constant-impedance controls, phonograph pickup faders, tone controls, line ballasts, rheostats, potentiometers and fixed resistors of various kinds, together with valuable circuit-design data. Contains many diagrams and charts, and a guide of replacement volume and tone controls for many commercial receivers. *Clarostat Manufacturing Company, Inc.*

6. **MEASURING RESISTANCES BY THE DEFLECTION METHOD.** The conventional method for the measurement of resistance involves the use of the Wheatstone bridge, a costly piece of apparatus. However, there are other methods which provide a fair degree of accuracy, enough for all practical purposes. The least expensive is the deflection method, which makes use of popularly priced milliammeters and fixed resistances. This bulletin describes the method completely, and should be very useful to Service Men and experimenters with limited meter equipment. *Shallcross Manufacturing Company.*

7. **SPEED RADIO TUBES.** Contains a chart of the electrical characteristics of the Speed tubes, and also a convenient list of broadcasting stations with space for dial settings. *Cable Radio Tube Corporation.*

8. **ELECTRAD PRODUCTS.** Descriptions of the full line of Electrad volume controls, voltage dividers, vitreous resistors, Truvolt adjustable resistors, amplifiers and other devices for radio and electrical applications. Among other diagrams, it includes twenty-four circuits showing the placement of volume controls in different types of broadcast receivers. *Electrad, Inc.*

9. **RECTIFIER TYPE INSTRUMENTS.** This type of instrument is used principally for measuring alternating currents of such small magnitude that they cannot be measured readily with ordinary types of A.C. instru-

On this page are listed booklets, catalogs and pamphlets of manufacturers, institutions and other organizations, which may be of interest to readers of RADIO-CRAFT. The list will be revised each month, and it will be kept as up-to-date and accurate as possible. In all cases the literature has been selected for mention because of the valuable information it contains. If you are interested in subjects not listed on this page, write us and we will try to serve you.

This Service is absolutely free to all readers of RADIO-CRAFT.

Fill in and mail the coupon below; make sure that your name and address are included and are plainly written. Order by number only.

ments. It consists of a sensitive D.C. meter used in conjunction with a rectifier made of four sets of copper-oxide disks arranged in the four arms of a Wheatstone bridge circuit. This folder, written by the chief engineer of the Weston company, describes the principles of operation, and is very interesting and instructive. *Weston Electrical Instrument Corporation.*

10. **THE CICO CELL.** Full technical description of a small photo-electric cell suitable for numerous applications, nine of which are illustrated. The pamphlet includes a dozen diagrams, four curves and detailed data. *Cico Instrument Company, Inc.*

11. **SUPREME INSTRUMENTS.** Contains lengthy descriptions of the Supreme service instruments, including the AAA1 Diagonometer, which is five instruments in one, the model 90 analyzer, the model 40 tube tester and the models 60 and 70 oscillators. Interesting to the Service Man because it tells how his work is facilitated by ingeniously designed test equipment that indicates the condition of an entire set in a few minutes. *Supreme Instrument Corporation.*

12. **VITROHM RESISTORS AND RHEOSTATS FOR RADIO.** Tells how vitreous enamel resistors are made and how they are used. The data on direct-current battery charging arrangements is of special value to people living in D.C. districts. *Ward Leonard Electric Company.*

RADIO-CRAFT (Reader's Service) 98 Park Place, New York, N. Y.

I am interested in securing a number of booklets on this page. Please have the following sent to me.

List by numbers

Name

Address

City and State.....

List of Books

Catalogs, Pamphlets, etc., are obtainable FREE with accompanying COUPON.

13. **AUDIO OUTPUT AND SPECIAL IMPEDANCE MATCHING TRANSFORMERS.** A twelve-page booklet describing the special construction of the Ferranti transformers and showing how they are employed in audio amplifiers. Two excellent diagrams are given; one for a two-stage amplifier using '45 or '50 tubes in the power stage, and the other for a three-stage outfit using '50 tubes in the output. All resistance and capacity values are included. *Ferranti, Inc.*

14. **STANDARD RESISTOR COLOR CODE.** This handy little card, measuring three by five inches, should be in every Service Man's kit. It illustrates and explains the standard R.M.A. method of marking fixed resistances with different combinations of colors to indicate the resistance value in ohms. It will save a lot of confusion in the field, as most resistors are now marked only by color, and do not bear figures at all. *Lynch Manufacturing Company, Inc.*

15. **YOU CAN LEARN CODE.** The Omigraph has been used for many years in the home study of both the radio and telegraph codes. This circular pictures the latest model and includes several diagrams and copies of the Continental (radio) and American Morse (telegraph) codes. *The Omigraph Manufacturing Company.*

16. **SEE THE ARTIST YOU ARE HEARING.** In addition to describing the Jenkins television receivers, this interesting pamphlet contains a well written explanation of modern television technique and practice that will clear many misunderstandings. *Jenkins Television Corporation.*

17. **CHARACTERISTICS OF TRIAD RADIO TUBES.** This legible chart gives the operating characteristics of the full line of Triad tubes, including the 866 mercury-vapor rectifier and the television types. The back of the chart is blank, so the whole sheet may be tacked to the wall above the service bench, or in the cover of a test kit. *Triad Manufacturing Company.*

18. **TRANSFORMER AND CHOKE BULLETIN.** Some of the important considerations entering into the design of choke coils are discussed and the specifications of several different kinds of chokes given. Power transformers for various purposes are also described. *Hilat Engineering Company.*

19. **A BAPTISM OF FIRE.** Centralab fixed resistors are made by forcing a carefully calibrated resistance material through a plastic ceramic material, and then baking both under terrific heat. This booklet describes the manufacturing process in detail, and lists the advantages claimed for fixed resistors of this type. It is interestingly written and illustrated, and makes good reading. *Central Radio Laboratories, Inc.*

20. **INSTRUCTIONS ON GRINDING QUARTZ CRYSTALS.** This is a valuable little folder for the radio amateur who wants to grind his own Piezo crystals for use in short-wave transmitters or oscillators. The instructions are clear and easily followed, and may be carried out with simple equipment. *American Piezo Supply Company.*

21. **READRITE RADIO INSTRUMENTS.** This sixteen-page pamphlet contains some valuable hints on the testing of electrolytic condensers, as well as descriptions of the full line of popular-priced Readrite instruments. Worth having. *Readrite Meter Works.*

\$100,000 Speaker Sale!

Included in this tremendous speaker sale are the products manufactured by leading speaker makers. Every speaker is brand new and shipped in original factory sealed cartons. They are sold far below their regular list price because they were bought in exceedingly large quantities and our purchase price permits us to give you the benefit of low cost.



DUO MAGNETIC

- Duo Magnetic Speaker ... **\$3.95**
 - Duo Inductor Dynamic Chassis ... **\$3.95**
- Similar to Farrand Inductor.

JENSEN

- A.C.—D.8 Dry Rectifier **\$14.95**
- A.C.—D.7 Jr. Audit Tube Rect. **\$12.95**
- A.C.—D.15 Concert Jr. Tube Rect. ... **\$8.50**
- D.9—2500 OHM D.C. Field **\$7.50**
- D.7—2500 OHM D.C. Field **\$8.50**
- D.15—Midget Concert Jr. 2500 OHMS **\$4.75**

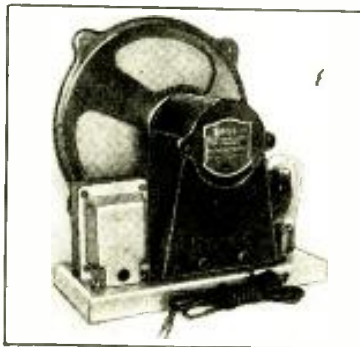

ROLA



- A. C. Models Model O-90-C A.C. using 280 Rect. **\$9.95**
- Model K. Midget A.C. using 280 Rect. **\$8.50**
- D. C. Models 2500 ohm P.P. Output Trans. **\$4.25**
- 1000 ohm P.P. Output Trans. **\$4.25**
- 2500 ohm Single Pentode. Each Model
- 2500 ohm Push Pull 238.
- 1000 ohm Single 238.
- 1800 ohm Single Pentode 300 ohm Tap for Bias.

BALDWIN

- A. C. using 280 Tube Rect. **\$7.50**
- D. C. 2500 OHM—110 Volts **\$5.50**
- D. C. 2500 OHM—110 Volts Field **\$4.00**
- Less Stand **\$3.25**
- D. C. 2500 OHM—110 Volts Field Less Output Trans. **\$3.25**

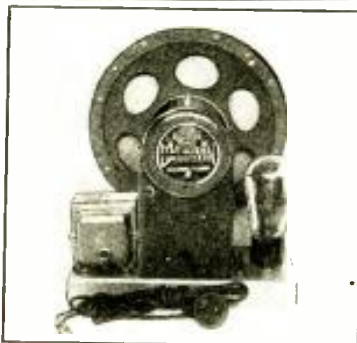

SANGAMO TRANSFORMERS

- Sangamo transformers are offered to the public for the first time at these reduced prices.
- Sangamo A. X. Audio Transformer. Price **\$1.75**
 - Sangamo B. X. pp Input Transformer. Price **\$1.95**
 - Sangamo H. X. pp Output Transformer. Price **\$1.95**



Do Not Write For Catalog!

All offers are F.O.B. New York, and subject to prior sale. Terms: A deposit of 20% is required with every order. Balance may be paid on delivery. Or, deduct 2% if full amount is sent with order.

OXFORD

- A. C. Models 14" Audit using 280 Rect **\$12.95**
 - 12" Concert Dynamic 280 Rect **\$8.95**
 - 9" Midget Dynamic 280 Rect **\$7.50**
 - D. C. Models 14" 5000 OHM Field **\$8.95**
 - 11" 2500 OHM Field **\$4.95**
 - 9" 2500 OHM Field **\$3.49**
- All 9" Midgets are supplied with Hum balancer



PEERLESS

- A.C. Models 12" A.C. Using Kodol Double Rect. and 2000 Mfd. Cond. **\$12.95**
- 12" A.C. using 280 Tube **\$12.50**
- D.C. Model 12" 1000 OHM Field 110 Volt D.C. Line **\$6.95**

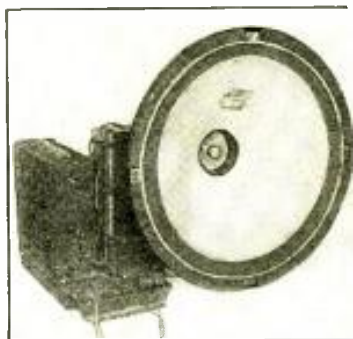

R.C.A. & VICTOR

- Victor A.C. Audit Model with Tube **\$12.25**
- Victor D.C. Audit 2500 Ohm **\$8.95**
- Victor D.C. Audit 2500 Ohms **\$7.95**
- Less output **\$7.95**
- R. C. A. A.C. With tube rect **\$12.50**
- D.C. 8000 ohm 300 V. Field **\$5.50**
- D.C. 8000 ohm 300 V. Field output **\$4.50**
- D.C. 800 ohm 110 V. Field 12 **\$7.50**

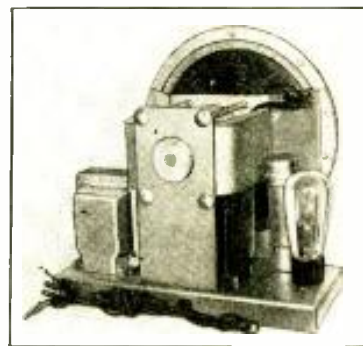

R.C.A. VICTOR MICROPHONE

This microphone is furnished with the latest model Radiola \$6 Home recording Super-Heterodyne Receiver and amplifier. Do not confuse this microphone with the "toy" type as it can be used for many professional and commercial uses. It is a single button "mike" with a gun metal finish. It's total length is 6½" and has as standard equipment a four foot cord.



YOUR PRICE

\$2.95

PENTODE ADAPTER



This Pentode Adapter permits the insertion of a type 247 Pentode Power Tube in place of the type 245 tube. Simply remove 245 tube, and insert the Adapter, and plug in the 247. **\$1.20**

OUR NET PRICE **\$1.20**

FARRAND INDUCTOR DYNAMICS

Used on A.C., D.C., and Battery Sets with Equal Results.

- 9" Model **\$5.95**
- 12" Model **\$6.95**



GREN PARK CO., Dept. R. C., 245 Greenwich Street, New York, N. Y.



25c
The Copy

9 x 12 Inches
Over 450 Illustrations
96 pages—
4-Color Cover

All that we claim it to be and better--

WE DO not hesitate to say that EVERYDAY SCIENCE AND MECHANICS is the finest scientific-technical-mechanical-constructional magazine in the field. Right up-to-the-minute with news flashes of scientific events from all parts of the world. Dozens of constructional articles for making useful things for the shop, garden and home. Many ideas from which you can make things to sell.

Get this magazine at your newsstand today. Read about the many cash prizes which are offered for simple experiments in photography, oddities in science, uses of old auto parts, radio experiments, recipes, formulas and others.

Mail Coupon TODAY!

EVERYDAY SCIENCE AND MECHANICS, RC-432
100 Park Place, New York, N. Y.

I enclose herewith One Dollar for which you are to send me EVERYDAY SCIENCE AND MECHANICS for the next Eight Months.

Name

Address

City and State

(Foreign or Canadian subscriptions not accepted at this rate.)

After reading your first issue, you'll agree with us that EVERYDAY SCIENCE AND MECHANICS is all that we claim it to be, and better.

Special Offer

The regular, yearly subscription price to EVERYDAY SCIENCE AND MECHANICS is \$2.50, newsstand rate \$3.00. For a limited time only we offer you

8 Months for \$1.00

CONTENTS for MARCH

EDITORIAL:
A Revolution in Foods

RADIO:
Operating Hints for Set Owners
Police Radio Installation
Radio for the Pocket
Radio Kinks
Radio Stethoscope
Radio Makes Violin an Orchestra
Short-Wave Receiver for "Ham" Bands

ASTRONOMY:
Is There Another Innermost Planet?

AUTOMOTIVE:
Auto Hints
New Automotive Devices
Old Auto Parts Prize Contest

AVIATION:
Building a Simple Model Glider
Featherweight Model Wheels
Glider Train
High-Altitude Mapping
Machine-Gun Camera
Novel Propeller
Tailless French Plane

BEST IDEA, TEN DOLLARS FOR THE BIOLOGY:
Sixty Thousand Eyes
What Are We Evolving?

CHEMISTRY:
Bunsen Burner from Standard Parts
Chemical Barometer
Chemistry in the Kitchen

CIGAR BOX-CRAFT \$500.00 PRIZE CONTEST

CONSTRUCTION:
Compressed-Air Model Speed Boat
Distinctive Furniture Ornaments
Model Ice, Land and Water Skiff
Model Railroad
Pee Wee Automobile
Small Crucible Furnace
Whistling Arrow

ELECTRICITY:
Electrocuting Insect Pests
New Electrical Devices
Oscillating Motor
Radium Rivalled by X-Ray Tube
Rocks Melt in Cold Furnace
Three Novelty Compasses

HOUSEHOLD MANAGEMENT:
Helpful Hints
Lamp from Bottle and Hose
New Inventions for the Household
Painting Your Own Home
Safety Ladder Hook
Storage Cellar Keeps Food Sweet
Wall Paper, to Loosen

METAL WORKING:
Decorative Work in Copper
Pewter Ware (Part II)
Shop Hints

MISCELLANEOUS:
Controlling San Francisco's Traffic
Convection Motor
Quackery Up-to-date
New Musical Instruments
Scienti-Mechanics Progress

ORACLE:

PATENT ADVICE:

PHOTOGRAPHY:
Infra-Red Photography in Darkness
Trick Photography

PRIZE CONTEST, \$100.00 Cover Picture Title SCIENCE AND ITS APPLICATIONS:
Models of Atoms
New Light on Familiar Objects
Rockets in the Next War
Science Makes It Possible
Science News of the Month
Simple Scientific Amusements
Sunlight Turned Into Power
X-Ray Microscope Proves Movement of Electrons

SCIENCE FORUM

SCIENTIFIC BOOKS, Review of New TELEVISION:
Monitoring Television
Television on a Light-Beam
Twenty-Four-Foot Image

WOODWORKING:
Amateur Woodworking Course
Book Rack
Buzz Saw from Old Sewing Machine
Cabinet Easily Made
Diving Wheel for Swimmers
Five-Compartment Lamp
Hanging Mirror
Living Room Table
Shop Hints

WRINKLES, RECIPES and FORMULAS CONSTRUCTIONAL ARTICLES
As always, there are too many of these to list at length; articles on wood turning and woodworking; model making; sheet metal work; scientific and chemical experiments; convenient and profitable hints for house decoration and furnishing; radio, etc.

BE THE BOSS OF YOUR OWN RADIO

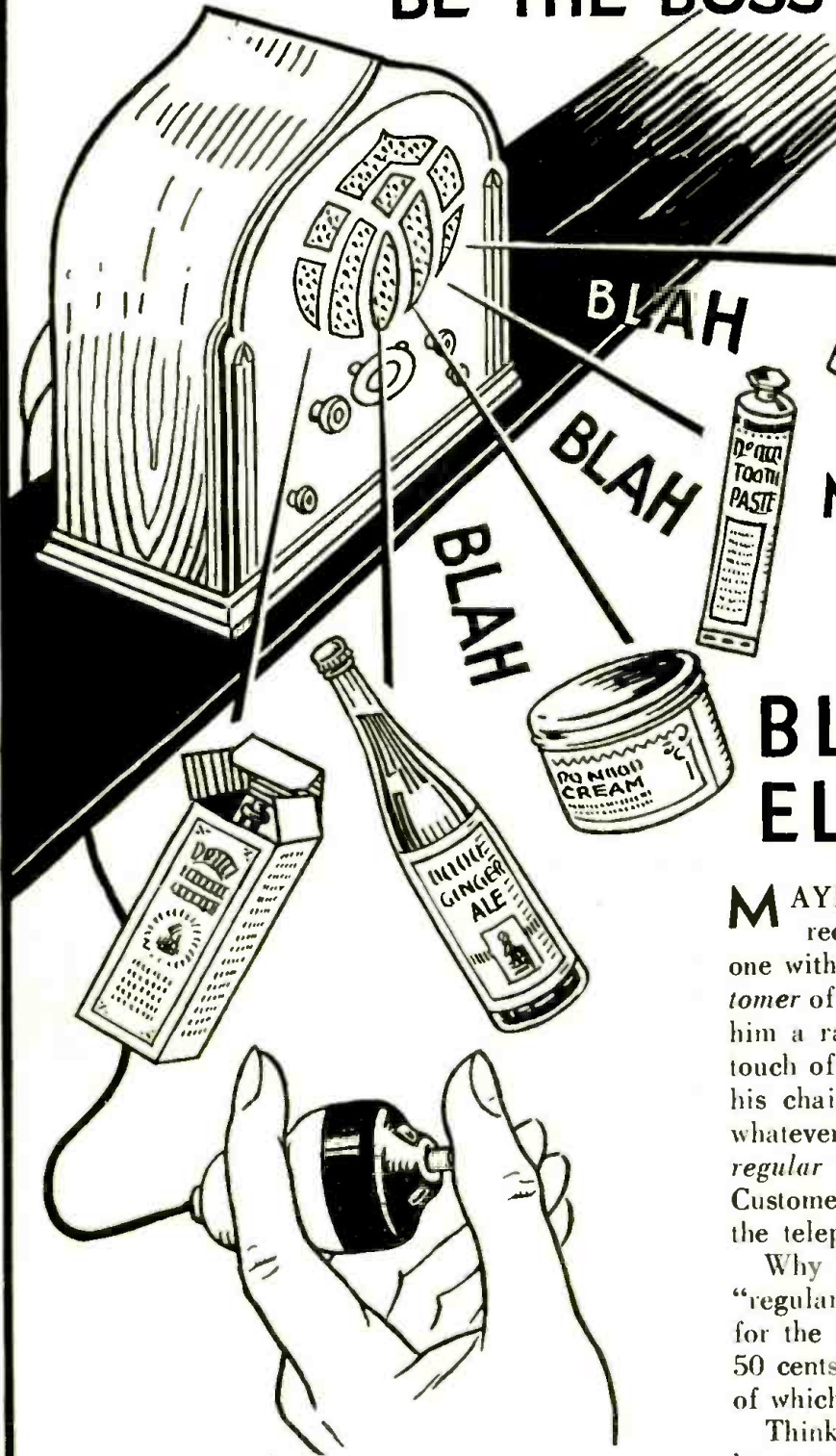

HERE'S
THE
SERVICE
MAN'S BEST SELLER

Doubles the Enjoyment
from Any Radio

BLAH BLAH ELIMINATOR

MAYBE you think a "good" broadcast receiver is a sharp-tuning, sensitive one with good tone fidelity. But that customer of yours—*what does he think?* Show him a radio that he can "shut up" at the touch of a button, without getting up from his chair, whenever it starts a volley of whatever he may call "blah." *There's a regular radio*—that's what Mr. and Mrs. Customer will think—and especially when the telephone rings!

Why not convert their old radio into a "regular" one, charging them only \$1.00 for the BLAH BLAH ELIMINATOR and 50 cents for your installation?—*over half* of which total represents *your profit*.

Think of the market—*everybody* that has a radio! Tell them in a minute what it will do—*demonstrate* it on any set in *another minute*. Sell only ten a day—install them on the spot, they're small and light to carry—and you have a mighty nice income, besides whatever else you take in. Send for your initial supply today—be the first in your community to offer this service that will be talked about at every gathering!

A slender silk-covered cord runs from antenna and ground posts (no connection with power wiring) to the neat, entirely insulated push button of the BLAH BLAH ELIMINATOR, which can be carried anywhere—to the customer's armchair, ironing board, or under the dining table. *One sample, to everyone* (note this protection) \$1.00 postpaid; to dealers and service men only, 1/2 dozen \$4.00, 1 dozen \$7.00 postpaid. Cash in advance; no accounts opened. *Money promptly refunded* on return of any sample in perfect condition within ten days.

COMPO MFG. CO.,

1255A S. Michigan Ave.,

Chicago

\$

Prices YOU can make a REAL profit on!

\$

GENERAL ELECTRIC Phonograph Induction Motor With 12 Inch Turntable

Designed to meet the demand for a reliable, noiseless and non-interfering electrically operated turntable for phonographs and radio-phonograph combinations. Has double phase, compound wound induction coils and disc type balanced armature, assuring quiet, smooth operation.

Governor controlled by lever and friction disc, setting of which amplifies proper torque for R. P. M. Constructed of the finest of electrical and mechanical parts. Equipped with 12 inch turntable. For 110 Volt, A.C.



OUR PRICE **\$7.50**

KOLSTER 245 Push Pull POWER AMPLIFIER and SPEAKER

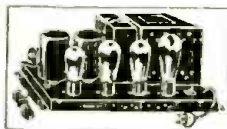

can be used with any tuner—for 110-115 volt the 227 in the first and two 245 tubes in the push pull stage, with a 280 rectifier. Kolster D. C. Dynamic Speaker to match, \$4.95 extra. D. C. LESS TUBES Field Resistance 2000 Ohms containing output transformer. Sold separately, without speaker. If desired.

OUR PRICE **\$13.95**

Genuine PHILCO Power Transformers

Philco Part No. 3516, for Philco Models 65, 76, 77, 77A and others using following Tubes: 3-221, 1-227, 2-245, 1-230.

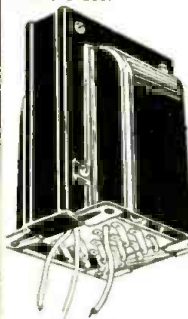

An excellent replacement transformer for most standard sets. Green and black wires, 125 V. Yellow wire C.T. of 7 and 9. Secondary connections shown on diagram.

Size: 3 3/4 in. 1 2 3 4
long, 3 1/2 in. 4 5 6 8
wide, 5 1/2 in. 7 8 8
high. 9 10

1 and 2-5 V. (280); 3-C.T. of High; 4 and 5-High V.; 6 and 10-2 1/2 V. (245); 8-C.T. of 6 and 10; 7 and 9-2 1/2 (227).

OUR PRICE **\$3.15**

Condenser Block for Majestic "B" Eliminator

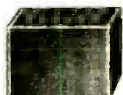

OUR PRICE

\$2.10

Replacement for defective blocks in "B" Eliminators—identical in electrical characteristics and outside dimensions. Can also be used in any make "B" Eliminator as well as most power packs

Kolster K-6 Speaker

Magnetic type cone speaker. Remarkable tone quality; volume to spare. Beautifully carved, fine Walnut cabinet. Equipped with highly sensitive oversize magnet and driving unit. Faithful reproduction from the faintest whisper to fullest volume of a brass band.



List \$20.00
OUR PRICE **\$3.35**

R. C. A. Loudspeaker 103

A beautiful speaker, superb in its faithful reproduction. Molded frame and pedestal resemble hand carved oak. Mechanism concealed by attractive tapestry.



(Genuine R.C.A.)
List \$18.00

OUR PRICE **\$3.43**

JENSEN SPEAKER Electro-Dynamic (Model D70C)

10 in. "Concert" D.C. These hum-free units contain suitable push-pull transformers and connect directly to the set—no outside wires 2500 ohm field. 8 ohm voice coil. As most standard A.C. sets are built for D.C. speakers of this ohmage, the possibilities for replacement with this really good speaker are unlimited.

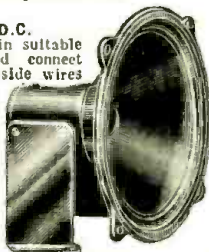

Act quickly. Quantity limited.
OUR PRICE **\$8.95**

Fixed Pigtail Resistors

OHMS

500	10,000	75,000
1,000	15,000	100,000
1,500	20,000	125,000
1,800	25,000	150,000
4,000	30,000	250,000
4,700	40,000	1 Megohm
5,000	60,000	2 Megohms

OUR PRICE **45c** PER DOZ.

Atwater-Kent Condenser & Filter Block

For Model 37 and 38 Sets Ideal filtering system for ANY make A. C. set using 171-A tube. Contains proper chokes and high voltage condensers. Flexible wire colored leads same as original.



HOOK-UP Green wire to 280, black to R.F. plate, yellow to Power Tube plate, white to first audio bypass, white to C.T. of 226 resistance, red to detector plate. Wire from can to ground.

OUR PRICE **\$2.40**

I.C.A. Test Leads—a necessity to the dealer or serviceman. Unsurpassed for testing sets and tracing shorts, opens and other common defects. Easily attached to testing meter or electrical apparatus. **40c**

A. C. DAYTON FLEWELLING SHORT WAVE ADAPTER

A.C. AND D.C. TYPES. This remarkable complete adapter makes a Short Wave Receiver out of any set without change of wiring. Short wave reception covering 18 to 84 meters is accomplished by 3 plug-in coils with non-corrosive nickel plated prongs, which give positive contact. There is nothing else to buy. The adapter is housed in a mahogany finished cabinet. Easy tuning with slow motion, smooth, vernier dial.

Model A-C UY. For sets using UY-227 A.C. tubes as first RF Amplifier or in the detector socket.

Model D-C UX. For sets using UX-201A, UX-199, WD-11, or A.C. 226 type tubes.

List Price \$15
OUR PRICE FOR A.C. OR D.C. MODEL

\$4.75



T. C. A. PUSH-PULL INPUT AUDIO TRANS- FORMER

Standard replacement transformer for Push-Pull formation using 171, 245, and 250 type tubes. Core of permalloy steel laminations bound by mounting brackets which serve as shield. Dimensions: 2x2x3 1/2 in.

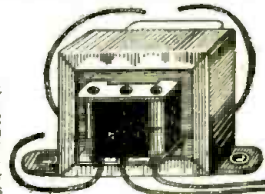

OUR PRICE **90c**

Victor ABC Power Transformer

For use with 6-226, 2-245, 1-227 and 1-280 tubes. Magnetically shielded preventing hum. Can safely be overloaded 30%. High voltages, 400 volts at 150 mils on either side of center tap. Extra large case especially designed to prevent overheating.

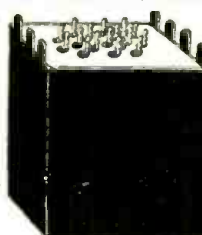

No. 1—Center tap of 9, 11—(5 volts)
No. 2, 4—2 1/2 Volts.
No. 5, 7—1 in. V. High amp. (226)
No. 3, 6—Primary (110 V. input)
No. 8—Center tap of 12, 17 (2 1/2 V.)
No. 9, 14—5 Volts (280).
No. 10, 15—High volt B supply.
No. 16—Center tap of above.
No. 12, 17—2 1/2 in. volts high amp. (224).

Size: 4 1/2 x 5 x 3 1/2 inches. Can be used for any power amplifier using 245 Tubes.

OUR PRICE **\$1.95**

FREE Catalog—means money to you These are only a few samples of the values to be found in our catalog. It is full of items on which you can make from 50% to 300% profit. And the best of them is, they are sound, well known, trademarked articles you can depend upon.

Send 20% with the order and articles will be shipped C.O.D. Order any of the above articles direct from this page. And be sure to ask for the catalog. It means money to you!

RADIO CIRCULAR CO.

225 Varick St. New York City

ORDER DIRECT...from this page!

TEAR IT OUT NOW!

RADIO CIRCULAR CO., 225 Varick Street, New York City

Enclosed find \$..... This is 20% of items listed below. I will pay balance upon receipt of merchandise.

We regret that we cannot accept orders under \$5.00

Name.....

Address.....

Send for FREE catalog!

RADIO CIRCULAR CO.
225 Varick Street, New York City

Please send me your catalog of radio bargains I can make a profit on.
I understand this obligates me in no way.

Name.....

Address.....

Also please send catalog. City..... State.....



J. E. Smith, President, National Radio Institute, the man who has directed the Home-Study training of more men for the Radio Industry than any other man in America.

BE A RADIO EXPERT

Many Make \$50 to \$100 a Week

I'll Train You at Home in Your Spare Time for RADIO-TELEVISION-TALKING MOVIES



Set Servicing

Spare-time set servicing pays many N.R.I. men \$200 to \$1,000 a year. Full-time men make as much as \$65, \$75 and \$100 a week.



Broadcasting Stations

Employ trained men continually for jobs paying up to \$5,000 a year.



Ship Operating

Radio operators on ships see the world free and get good pay plus expenses.

Aircraft Radio

Aviation is needing more and more trained Radio men. Operators employed through Civil Service Commission earn \$1,620 to \$2,800 a year.

If you are dissatisfied with your present job, if you are struggling along in a rut with little or no prospect of anything better than a skinny pay envelope—clip the coupon NOW. Get my big FREE book on the opportunities in Radio. Read how quickly you can learn at home in your spare time to be a Radio Expert—what good jobs my graduates have been getting—real jobs with real futures.

Talking Movies, Television, Aircraft Radio Included in N. R. I. Training

Special training in Talking Movies, Television and home Television experiments, Radio's use in Aviation, Servicing and Merchandising Sets, Broadcasting, Commercial and Ship Stations are included. I am so sure that N.R.I. can train you satisfactorily that I will agree in writing to refund every penny of your tuition if you are not satisfied with my Lessons and Instruction Service upon completion.

Many Radio Experts Make \$50 to \$100 a Week

In about ten years the Radio Industry has grown from a \$2,000,000 to hundreds of millions of dollars. Over 300,000 jobs have been created by this growth, and thousands more will be created by its continued development. Many men and young men with the right training—the kind of training I give you in the N.R.I. course—have stepped into Radio at two and three times their former salaries.

64-Page Book of Information FREE

Get your copy today. It tells you where Radio's good jobs are, what they pay, tells you about my course, what others who have taken it are doing and making. Find out what Radio offers you without the slightest obligation. ACT NOW!

Get Ready Now for Jobs Like These

Broadcasting stations use engineers, operators, station managers, and pay up to \$5,000 a year. Manufacturers continually employ testers, inspectors, foremen, engineers, service men, buyers, for jobs paying up to \$4,000 a year. Radio Operators on ships enjoy life, see the world, with board and lodging free, and get good pay besides. Dealers and jobbers employ service men, salesmen, buyers, managers, and pay up to \$100 a week. My book tells you about these and many other kinds of interesting radio jobs.

J. E. SMITH, President
National Radio Institute
Dept. 2DX
Washington, D. C.



Many N. R. I. Men Have Made \$200 to \$1000 in Spare Time While Learning

The day you enroll with me I'll show you how to do 28 jobs, common in most every neighborhood, for spare time money. Throughout your course I send you information on servicing popular makes of sets; I give you the plans and ideas that have made \$200 to \$1,000 for N.R.I. students in their spare time while studying. My course is famous as the course that pays for itself.

THIS COUPON IS GOOD for
One FREE COPY OF MY BOOK *mail it now*

Special Free Offer

"28 Tested Methods for Making Extra Money"



In addition to my big free book "Rich Rewards in Radio," I'll send you my valuable manual "28 Tested Methods for Making Extra Money." Never before available except to students. Now, for a limited time, it is free to readers of this magazine. How to make a good baffle for cone speakers, how to reduce hum in externally fed dynamic speakers, how to operate 25 cycle apparatus on 60 cycle current, how to operate 110 v. A. C. receivers on D. C., how to shield sets from local interference are five of the subjects covered. There are 23 others. Get this valuable book by mailing the coupon now.

J. E. SMITH, President
National Radio Institute, Dept. 2DX
Washington, D. C.

Dear Mr. Smith:
I want to take advantage of your special Offer. Send me your two books "28 Tested Methods in Making Extra Money" and "Rich Rewards in Radio." I understand this does not obligate me and that no salesman will call.

Name.....
Address.....
City.....State..... "J"

Television

The coming field of many great opportunities is covered by my course.



SERVICE MEN WANTED

There is a real change in every part of the radio business. A change which can bring great benefits to you. Radio Receivers are being sold for a song and unfortunately many of them are filled with inferior tubes, when they are sold. You can make a real friend of the purchaser of every such receiver by filling all his sockets with good tubes. But that is not the whole story.

The Triad Mfg. Co. is the first manufacturer to recognize the vital part you servicemen play in this new radio business. Triad knows that, with your confidence, a greater number of users of Triad tubes can be reached. Therefore, the directors have decided to make actual partners of some of you and permit you to sell them.

TRIADS HAVE ALWAYS BEEN GOOD TUBES

The Directors of the Triad Mfg. Co. have been in the tube business for many years. They are in constant contact with men like you every day. They are very familiar with the problems you have to face. They have always given you tubes you could bank on. They have assisted you in building up satisfied clientele, by giving you the one most important unit of radio service—a good tube.

For example:

Do you know that of the millions of tubes bought from Triad, last year, less than four per cent were defective and that includes those damaged in shipment. When you consider the very broad guarantee behind all Triad Tubes, this return is remarkably low. It must indicate what these tubes can be made to mean to your business.

CERTIFIED TRIAD TUBES

These new tubes are being made specially for servicemen. They are going to you right from the factory. They are packed with an engineering coupon which indicates exactly what their constants are after they have been permitted to age and have then been checked for the second time. This assures you of their being absolutely correct, in every detail. It assures you of satisfied customers. It assures you of a permanent, profitable business.

And you can have these tubes, at no increased cost. In fact, under most conditions you can buy them at a great saving. In other words, TRIAD is offering you an opportunity to give your customers greater satisfaction at the same time you make a greater profit out of every sale.

YOU CAN BECOME A TRIAD REPRESENTATIVE

While it is the purpose of the Triad Company to cooperate with all Servicemen, it is also desirable to be sure that every serviceman who sells **CERTIFIED TRIAD TUBES** will not find that every other serviceman in his vicinity can compete with him. **YOU ARE TO BE PROTECTED** and we will definitely limit the number of men in any one section, who will be permitted to purchase **CERTIFIED TRIADS** on this new, money-making plan.

We want you to know all the details of this wonderful new sales plan. It has been designed for the servicemen, in all parts of the country, who can measure up to the TRIAD qualifications. Every assistance will be given to the men selected, but they must be the key men in their territories. Triad has no place for dead wood. Triad wants men who can carry on the Triad tradition and who can render the same quality of Service that Triad is building into every one of the thirty different types of tubes it makes. If you think you can measure up to that standard and you want to assure yourself of a growing, lasting, profitable business, you will find your opportunity waiting for you, below



TRIAD MANUFACTURING CO.
TELEVISION MFG. CO.
Pawtucket, R. I.

Gentlemen:

Please send me complete information about your new Sales Plan for servicemen.

I have been a serviceman for years.

I sell tubes per year.

I belong to the Serviceman's Association.

My letterhead or card is attached.

A CORNER OF THE AUTOMATIC FLARE AND MOUNT DEPARTMENT
Triad Mfg. Co., Plant No. 1

RADIO DEALERS and SERVICEMEN

Here are two live items that wide-awake Dealers and Servicemen can cash in on.

THE RADIO DEALERS' ANTENAPLEX KIT

This RCA Antenaplex System, when properly installed, due to its superior design and complete shielding, transmits to the Outlet whatever the installed antenna receives. Interference that is not actually picked up at the antenna will be sealed out and not transmitted to the receivers. This system has been found very satisfactory to a great number of Dealers located in crowded and congested districts, where they have been bothered with a great deal of local interference. Many of you dealers who read this will know from sad experience what interference in radio reception will do when demonstrating good sets. It means many a sale lost through no fault of the set or your sales ability. Why not install one of these systems and decrease sales resistance?

The RCA Antenaplex Kit, Model RF-5000, consists of the following parts:

- 1—RCA Antensifier Box—Model RF-5001
- 1—RCA Antensifier—Model RF-5002
- 100 Feet—RCA Cabloy—Model RF-5050
- 100—RCA Cabloy Clamps—Model RF-5055
- 10—RCA Taplets—Model RF-5031
- 10—RCA Radio Outlet Flush Plates—Model RF-5634
- 1—RCA Terminet—Model RF-5091

Special Net Price to Dealers...\$100.00

An attractive proposition awaits Radio Service Organizations or Servicemen doing a fair volume of business who are equipped to handle the RCA Antenaplex System. If you have contacts with Electrical and Building Contractors or are in a position to closely contact apartment house owners, write us for further information.



One of the many uses of the Radio Pillow



The Radio Dealers' Antenaplex Kit

THE RADIO PILLOW

Feature these Radio Pillows to your trade. Every customer is a prospect. Independent Servicemen and Servicemen connected with Radio Dealers send for literature telling of the many uses and sales appeal of this product. It allows an individual to listen-in to their favorite program without disturbing others. Ideal for use in Guest Rooms, Nurseries, Hospitals, etc.

List Price\$6.95



Centralized Radio System

RCA Victor Co., Inc.

A Radio Corporation of America Subsidiary
Camden, New Jersey

"RADIO HEADQUARTERS"

Centralized Radio Section
RCA Victor Co., Inc.
Camden, N. J.

Please send me full details on

- The Radio Dealers' Antenaplex System
- The RCA Antenaplex System
- The Radio Pillow

Name.....

Address.....